

PROPRIETARY NOTICE AND LIABILITY DISCLAIMER

The information disclosed in this document, including all designs and related materials, is the valuable property of NEC Computer Systems Division, Packard Bell NEC, Inc. (hereinafter "NEC CSD") and/or its licensors. NEC CSD and/or its licensors, as appropriate, reserve all patent, copyright and other proprietary rights to this document, including all design, manufacturing, reproduction, use, and sales rights thereto, except to the extent said rights are expressly granted to others.

The NEC CSD product(s) discussed in this document are warranted in accordance with the terms of the Warranty Statement accompanying each product. However, actual performance of each such product is dependent upon factors such as system configuration, customer data, and operator control. Since implementation by customers of each product may vary, the suitability of specific product configurations and applications must be determined by the customer and is not warranted by NEC CSD.

To allow for design and specification improvements, the information in this document is subject to change at any time, without notice. Reproduction of this document or portions thereof without prior written approval of NEC CSD is prohibited.

Direction is a trademark of Packard Bell NEC, Inc.

NEC and MultiSync are registered trademarks of NEC Corporation, used under license.

All other product, brand, or trade names used in this publication are the trademarks or registered trademarks of their respective trademark owners.

First Printing — April 1998

Copyright 1998
NEC Computer Systems Division
Packard Bell NEC, Inc.
1414 Massachusetts Avenue
Boxborough, MA 01719-2298
All Rights Reserved

Contents

	Page
Preface.....	xi
Abbreviations.....	xiii
Section 1 Technical Information	
System Board	1-4
Processor.....	1-4
System Cache/Memory	1-4
Chipset	1-5
PCI Local Bus	1-5
Expansion Bus	1-6
BIOS	1-6
Plug and Play Support.....	1-7
CMOS Memory/Real-Time Clock Battery	1-8
DMA/IRQ Settings	1-8
IDE Ports	1-9
I/O Ports.....	1-9
Sound System	1-10
U.S. Robotics Modem Board (Optional)	1-10
Diskette Drive.....	1-10
Hard Disk Drive.....	1-11
Cd-Rom/Dvd Drive.....	1-11
Zip Drive	1-11
Power Supply	1-11
Power Management	1-11
Section 2 Setup Utility	
Configuration Information.....	2-1
When to Use Setup	2-1
How to Start Setup.....	2-2
How to Use Setup	2-3
Menu Bar.....	2-3
Legend Bar	2-4
Selecting a Menu Item	2-4
Displaying a Submenu.....	2-4

Getting Help	2-4
Main Menu	2-5
Floppy Options Submenu	2-6
Primary/Secondary IDE Master/Slave Submenus.....	2-7
Advanced Menu.....	2-9
Resource Configuration Submenu	2-10
Peripheral Configuration Submenu	2-10
Keyboard Configuration Submenu.....	2-12
Video Configuration Submenu	2-13
DMI Event Logging Submenu.....	2-13
Security Menu	2-14
Power Menu	2-14
Boot Menu	2-15
Hard Drive Submenu.....	2-15
Removable Drive Submenu	2-16
Exit Menu.....	2-16

Section 3 Option Installation

General Rules for Installing Options.....	3-1
Precautions	3-2
Removing the Access Cover.....	3-3
Replacing the Access Cover.....	3-4
Expansion Boards	3-5
Expansion Slot Locations.....	3-5
Expansion Board Installation.....	3-6
Expansion Board Removal	3-7
DIMM Upgrade.....	3-7
DIMM Removal.....	3-9
DIMM Installation	3-10
Video Upgrade	3-11
Data Storage Devices.....	3-11
Device Slots.....	3-11
Device Preparation.....	3-12
Device Cables	3-13
Diskette Drive Signal Cable.....	3-13
IDE Signal Cables	3-14
System Power Cables.....	3-15

Device Cabling.....	3-16
Cabling an IDE Device.....	3-16
Cabling an Accessible 5 1/4-Inch Device	3-17
Storage Device Installation.....	3-18
Removing the Front Panel.....	3-18
Removing the CD-ROM/DVD Drive.....	3-18
Installing a 3 1/2-Inch Device	3-19
Installing a 5 1/4-Inch Device	3-23
Replacing the Front Panel.....	3-24
Adding External Options.....	3-25
Parallel Printer	3-25
RS-232C Device Connection.....	3-27

Section 4 Maintenance and Troubleshooting

Maintenance	4-2
System Cleaning.....	4-2
Keyboard Cleaning.....	4-3
Mouse Cleaning	4-3
Troubleshooting.....	4-5
Diagnosing and Solving Problems	4-5
Beep Codes.....	4-11
CMOS Battery Replacement	4-11

Section 5 Disassembly and Reassembly

Disassembly	5-2
System Access Cover.....	5-2
Expansion Board Removal	5-2
Front Panel Removal.....	5-3
Side Panel Removal	5-4
Device Cage Removal.....	5-4
Diskette Drive Removal	5-4
5 1/4-Inch Device Removal.....	5-5
Optional 3 1/2-Inch Hard Disk Drive Removal	5-6
Standard 3 1/2-Inch Hard Disk Drive Removal.....	5-8
Fan Assembly Removal	5-8
DIMM Module Removal.....	5-9
Power Supply Removal.....	5-10

System Board Removal	5-11
Illustrated Parts Breakdown	5-11

Appendix A System Specifications

Appendix B Connector Pin Assignments

Serial Interface Connectors	B-4
Parallel Interface Connector	B-5
Power Supply (Primary).....	B-6
Keyboard and Mouse Connectors.....	B-6
Front Panel	B-7
Diskette Drive Interface Pin Assignments	B-8
IDE Interface Connectors	B-9
DIMM Sockets	B-10
AGP Connector	B-11
ISA Expansion Bus Connector Pin Assignments.....	B-12
PCI Expansion Bus Connector Pin Assignments.....	B-14
Universal Serial Bus (USB) Connectors	B-15

Appendix C System Resources

IRQ Settings	C-1
Viewing System Resources	C-2
Setting the Jumper	C-2
Clearing Your Password	C-3
Recovering the BIOS	C-4

Figures

Figure 3-1 Releasing the Cover	3-4
Figure 3-2 Aligning the Tabs.....	3-4
Figure 3-3 Locating Expansion Slots.....	3-6
Figure 3-4 Removing the Slot Cover	3-6
Figure 3-5 Removing a DIMM.....	3-10
Figure 3-6 Installing a DIMM	3-11
Figure 3-7 Locating Device Slots	3-12
Figure 3-8 System Board Cable Connectors	3-13
Figure 3-9 Diskette Drive Signal Cable	3-14

Figure 3-10 IDE Signal Cable	3-15
Figure 3-11 Power Cable Connectors.....	3-15
Figure 3-12 Connecting IDE Device Cables	3-16
Figure 3-13 Connecting an Accessible 5 1/4-Inch Device	3-17
Figure 3-14 Releasing the Front Panel.....	3-18
Figure 3-15 Removing the Device Cage Screw.....	3-19
Figure 3-16 Locating Device Slots	3-20
Figure 3-17 Removing the Bracket Screws.....	3-20
Figure 3-18 Aligning the Holes and Tabs.....	3-21
Figure 3-19 Securing the Disk.....	3-21
Figure 3-20 Inserting the Device	3-22
Figure 3-21 Removing the Blank Panel	3-22
Figure 3-22 Installing the Device.....	3-24
Figure 3-23 Locating the Parallel Port.....	3-26
Figure 3-24 Locating COM1 and COM2.....	3-27
Figure 4-1 Removing the Mouse Ball Cover.....	4-4
Figure 4-2 Locating the Battery	4-12
Figure 5-1 Removing a Board	5-3
Figure 5-2 Releasing the Front Panel.....	5-3
Figure 5-3 Locating the Device Cage Screw.....	5-4
Figure 5-4 Locating the Two Diskette Drive Clips	5-5
Figure 5-5 Removing the 5 1/4-Inch Device Screws	5-6
Figure 5-6 The 3 1/2-Inch Device Bracket Screws	5-7
Figure 5-7 Removing the Securing Screw.....	5-7
Figure 5-8 Removing the Drive	5-8
Figure 5-9 Removing a DIMM.....	5-9
Figure 5-10 Removing the Power Supply Screws.....	5-10
Figure 5-11 Removing the System Board Screw.....	5-11
Figure 5-12 Direction L Series Desktop Illustrated Parts Breakdown	5-15
Figure 5-13 Direction L Series Minitower Illustrated Parts Breakdown	5-19
Figure 5-14 Direction SPL and SP Series Desktop Illustrated Parts Breakdown	5-23
Figure 5-15 Direction SPL and SP Series Minitower Illustrated Parts Breakdown	5-27
Figure B-1 System Board Connectors and Slots	B-2
Figure B-2 System Board External Connectors	B-2

Figure C-1 Locating the Jumper	C-2
--------------------------------------	-----

Tables

Table 1-1 L Series System Features.....	1-2
Table 1-2 SPL Series System Features	1-3
Table 1-3 SP Series System Features.....	1-4
Table 1-4 System Memory Map	1-7
Table 1-5 Interrupt Level Assignments.....	1-8
Table 1-6 DMA Assignments	1-9
Table 2-1 Setup Key Functions	2-4
Table 3-1 Sample Memory Configurations	3-9
Table 4-1 NEC CSD Service and Information Telephone Numbers	4-1
Table 4-2 Problems and Solutions	4-5
Table 4-3 Beep Code Descriptions	4-11
Table 5-1 Disassembly Sequence.....	5-1
Table 5-2 Direction L Series Desktop Field-Replaceable Parts List.....	5-12
Table 5-3 Direction L Series Minitower Field-Replaceable Parts List.....	5-16
Table 5-4 Direction SPL and SP Series Desktop Field-Replaceable Parts List.....	5-20
Table 5-5 Direction SPL and SP Series Minitower Field-Replaceable Parts List.....	5-24
Table 5-6 Memory Options	5-28
Table 5-7 Direction Series Documentation	5-28
Table B-1 System Board Connectors.....	B-1
Table B-2 System Board Internal Connectors.....	B-3
Table B-3 System Board Connector Numbers and Types	B-3
Table B-4 RS-232C Serial Port Connector Pin Assignments	B-4
Table B-5 Parallel Port Connector Pin Assignments	B-5
Table B-6 Primary Power Supply Connector Pin Assignments.....	B-6
Table B-7 Keyboard and Mouse Connector Pin Assignments	B-6
Table B-8 Front Panel Connector Pin Assignments.....	B-7
Table B-9 Diskette Drive Connector Pin Assignments	B-8
Table B-10 IDE/PCI Connector Pin Assignments.....	B-9
Table B-11 DIMM Socket Pin Assignments	B-10
Table B-12 AGP Connector Pin Assignments.....	B-11

Table B-13 ISA Expansion Slot Pin Assignments B-12
Table B-14 PCI Expansion Pin Assignments..... B-14
Table B-15 USB Connectors..... B-15

Table C-1 System Board Jumper Settings..... C-3

Preface

This service and reference manual contains technical information necessary for servicing and repairing Direction L Series, SPL Series, and SP Series systems. The manual includes system setup information, procedures for installing options, and troubleshooting. The manual is written for NEC CSD-trained customer engineers, system analysts, service center personnel, and dealers.

The manual is organized as follows:

Section 1 — Technical Information, provides an overview of the computer features, hardware design, interface ports, and internal devices.

Section 2 — Setup Utility, includes procedures for configuring the system through the Setup utility program

Section 3 — Option Installation, provides installation procedures for adding optional expansion boards, diskette and hard disk storage devices, system memory, and processor updates.

Section 4 — Maintenance and Troubleshooting, includes recommended maintenance information, lists possible computer problems and their solutions, and has battery replacement procedures.

Section 5 — Disassembly and Reassembly, includes computer disassembly and reassembly procedures.

Appendix A — System Specifications, provides a list of the system specifications including dimensions, weight, environment, safety compliance, power consumption, and memory.

Appendix B — Connector Pin Assignments, provides a list of the internal and external system board connector pin assignments.

Appendix C — System Resources, includes information on IRQ settings and system board jumpers.

Abbreviations

A	ampere	DMAC	DMA controller
AC	alternating current	DOS	disk operating system
AT	advanced technology (IBM PC)	DRAM	dynamic RAM
BBS	Bulletin Board Service	ECC	error checking and correction
BCD	binary-coded decimal	EDO	extended data output
BCU	BIOS Customized Utility	EGA	Enhanced Graphics Adapter
BIOS	basic input/output system	EPROM	erasable and programmable ROM
bit	binary digit	EVGA	Enhanced Video Graphics Array
BUU	BIOS Upgrade Utility	F	Fahrenheit
bpi	bits per inch	FAX	facsimile transmission
bps	bits per second	FCC	Federal Communications Commission
C	capacitance	FG	frame ground
C	centigrade	FM	frequency modulation
Cache	high-speed buffer storage	FP	fast page
CAM	constantly addressable memory	FRU	field-replaceable unit
CAS	column address strobe	GB	gigabyte
CD-ROM	compact disk-ROM	GND	ground
CG	character generator	HEX	hexadecimal
CGA	Color Graphics Adapter	HGA	Hercules Graphics Adapter
CGB	Color Graphics Board	Hz	hertz
CH	channel	IC	integrated circuit
clk	clock	ID	identification
cm	centimeter	IDE	intelligent device electronics
CMOS	complementary metal oxide semiconductor	IDTR	interrupt descriptor table register
COM	communication	in.	inch
CONT	contrast	INTA	interrupt acknowledge
CPGA	ceramic pin grid array	IPB	illustrated parts breakdown
CPU	central processing unit	IR	infrared
DAC	digital-to-analog converter	IRR	Interrupt Request register
DACK	DMA acknowledge	ISA	Industry Standard Architecture
DC	direct current	ISR	In Service register
DIP	dual in-line package	I/O	input/output
DLAB	Divisor Latch Address bit		
DMA	direct memory access		

IPC	integrated peripheral controller	PLCC	plastic leaded chip carrier
ips	inches per second	PLL	phase lock loop
IRQ	interrupt request	p-p	peak-to-peak
K	kilo (1024)	PPI	programmable peripheral interface
k	kilo (1000)	PROM	programmable ROM
KB	kilobyte	QFP	quad flat pack
kg	kilogram	RAM	random-access memory
kHz	kilohertz	RAMDAC	RAM digital-to-analog converter
lb	pound	RAS	row address strobe
LED	light-emitting diode	RGB	red green blue
LSB	least-significant bit	RGBI	red green blue intensity
LSI	large-scale integration	ROM	read-only memory
M	mega	rpm	revolutions per minute
mA	milliamps	R	read
max	maximum	RTC	real-time clock
MB	megabyte	R/W	read/write
MDA	Monochrome Display Adapter	S	slave
MFM	modified frequency modulation	SCSI	Small Computer System Interface
MHz	megahertz	SG	signal ground
mm	millimeter	SIMM	single inline memory module
ms	millisecond	SPM	standard page mode
MSB	most-significant bit	SRS	Sound Retrieval System
NASC	National Authorized Service Center	SVGA	Super Video Graphics Array
NC	not connected	SW	switch
NMI	Non-maskable Interrupt	TAC	Technical Assistance Center
ns	nanosecond	TSC	Technical Support Center
NSRC	National Service Response Center	TTL	transistor/transistor logic
PAL	programmable array logic	tpi	tracks per inch
PC	personal computer	USB	universal serial bus
PCB	printed circuit board	V	volt
PCI	Peripheral Component Interconnect	Vac	volts, alternating current
PDA	personal digital assistant	Vdc	volts, direct current
PFP	plastic flat package	VESA	video electronics standards association
PIO	parallel input/output		
pixel	picture element		

VFC	VESA-compliant feature connector
VGA	Video Graphics Array
VRAM	video RAM
W	watt
W	write

Section 1

Technical Information

The Direction™ L Series, SPL Series, and SP Series of desktop and minitower Pentium II systems include the following configurations:

- Direction 233L
- Direction 266L
- Direction 300L
- Direction 333L
- Direction SPL233 with 24x CD-ROM drive
- Direction SPL266 with 24x CD-ROM drive
- Direction SPL300 with 24x CD-ROM drive
- Direction SPL333 with 24x CD-ROM drive
- Direction SPL233 with 32x CD-ROM drive
- Direction SPL266 with 32x CD-ROM drive
- Direction SPL300 with 32x CD-ROM drive
- Direction SPL333 with 32x CD-ROM drive

This section provides an overview of the NEC Direction L Series, SPL Series, and SP Series computers. These systems include the Intel® Pentium® II processor with MMX™ technology. Table 1-1 describes the standard features of the L Series models. Table 1-2 describes the standard features of the SPL Series models. Table 1-3 describes the standard features of the SP Series models.

The subsections that follow provide more detailed information on the system features.

Table 1-1 L Series System Features

Feature	Direction 233L	Direction 266L	Direction 300L	Direction 333L
Processor	Intel Pentium II 233-MHz MMX	Intel Pentium II 266-MHz MMX	Intel Pentium II 300-MHz MMX	Intel Pentium II 333-MHz MMX
System RAM	32 MB to 192 MB	32 MB to 192 MB	32 MB to 192 MB	32 MB to 192 MB
Secondary Cache	512 KB, pipeline burst	512 KB, pipeline burst	512 KB, pipeline burst	512 KB, pipeline burst
Chipset	Intel 440LX	Intel 440LX	Intel 440LX	Intel 440LX
Graphics	AGP graphics board	AGP graphics board	AGP graphics board	AGP graphics board
Video Memory	4 MB SGRAM	4 MB WRAM	4 MB WRAM	4 MB WRAM
Sound	Sound Retrieval System [®]	Sound Retrieval System	Sound Retrieval System	Sound Retrieval System
Hard Disk	3.2 GB - 9 GB	3.2 - 9 GB	3.2 - 9 GB	3.2 - 9 GB
CD-ROM Drive	24x	24x	24x	24x
Power Supply	235 W	235 W	235 W	235 W

Table 1-2 SPL Series System Features

Feature	Direction SPL233	Direction SPL266	Direction SPL300	Direction SPL333
Processor	Intel Pentium II 233-MHz MMX	Intel Pentium II 266-MHz MMX	Intel Pentium II 300-MHz MMX	Intel Pentium II 333-MHz MMX
System RAM	32 MB to 192 MB	32 MB to 192 MB	32 MB to 192 MB	32 MB to 192 MB
Secondary Cache	512 KB, pipeline burst	512 KB, pipeline burst	512 KB, pipeline burst	512 KB, pipeline burst
Chipset	Intel 440LX	Intel 440LX	Intel 440LX	Intel 440LX
Graphics	AGP graphics board	AGP graphics board	AGP graphics board	AGP graphics board
Video Memory	4 MB SGRAM	4 MB WRAM	4 MB WRAM	4 MB WRAM
Sound	Sound Retrieval System	Sound Retrieval System	Sound Retrieval System	Sound Retrieval System
Hard Disk	3.2 GB - 9 GB	3.2 - 9 GB	3.2 - 9 GB	3.2 - 9 GB
CD-ROM Drive	24x	24x	24x	24x
Power Supply	235 W	235 W	235 W	235 W

Table 1-3 SP Series System Features

Feature	Direction SPL233	Direction SPL266	Direction SPL300	Direction SPL333
Processor	Intel Pentium II 233-MHz MMX	Intel Pentium II 266-MHz MMX	Intel Pentium II 300-MHz MMX	Intel Pentium II 333-MHz MMX
System RAM	32 MB to 192 MB	32 MB to 192 MB	32 MB to 192 MB	32 MB to 192 MB
Secondary Cache	512 KB, pipeline burst	512 KB, pipeline burst	512 KB, pipeline burst	512 KB, pipeline burst
Chipset	Intel 440LX	Intel 440LX	Intel 440LX	Intel 440LX
Graphics	AGP graphics board	AGP graphics board	AGP graphics board	AGP graphics board
Video Memory	4 MB SGRAM	4 MB WRAM	4 MB WRAM	4 MB WRAM
Sound	Sound Retrieval System	Sound Retrieval System	Sound Retrieval System	Sound Retrieval System
Hard Disk	3.2 GB - 9 GB	3.2 - 9 GB	3.2 - 9 GB	3.2 - 9 GB
CD-ROM Drive	32x	32x	32x	32x
Power Supply	235 W	235 W	235 W	235 W

SYSTEM BOARD

The system board contains most of the components that provide system functions. The following subsections provide a description of these components.

Processor

Depending on the model, the system board uses a 233-MHz, 266-MHz, 300-MHz, or 333-MHz Intel Pentium II processor with MMX technology. The MMX processor improves audio, video, and 3D graphics performance.

The processor is packaged in a Single Edge Contact (SEC) cartridge and the cartridge plugs into the system board's slot 1.

System Cache/Memory

To utilize the processor's power, the system features an optimized 64-bit memory interface and provides support for a second level cache to compliment the processor's internal cache.

High-performance features include:

- pipeline 32-bit addressing
- 64-bit data
- 512-KB of pipeline burst secondary cache; direct mapped write-back and write-through organization.

Depending on the model, the system comes with 32 to 192 MB of main system memory. Three sockets on the system board support up to 384 MB of high-speed memory using industry-standard gold-plated dual in-line memory modules (DIMMs).

The system supports 60-ns Synchronous DRAM (SDRAM).

The system supports the following 60-ns configurations:

- 1-Mbit by 64 or 72 (8-MB DIMM)
- 2-Mbit by 64 or 72 (16-MB DIMM)
- 4-Mbit by 64 or 72 (32-MB DIMM)
- 8-Mbit by 64 or 72 (64-MB DIMM)
- 16-Mbit by 64 or 72 (128-MB DIMM).

Chipset

The Intel 440LX chipset provides DMA, memory, and bus control. The chipset includes the following chips:

- Intel 82443LX PCI/A.G.P. (PAC) — provides bus-control signals, address paths, and data paths for transfers between the processor's host bus, PCI bus, Accelerated Graphics Port (AGP), and main memory.
- Intel 82371AB PCI/ISA IDE Xccelerator (PIIX4) — implements the PCI-to-ISA bridge, PCI IDE functionality, Universal Serial Bus (USB) host/hub functions, and enhanced power management.

PCI Local Bus

The 32-bit industry-standard PCI bus is a highly-integrated input/output (I/O) interface that offers the highest performance local bus available for the Pentium II processor. The PCI bus supports burst modes that send large chunks of data across the bus, allowing fast displays of high-resolution images.

The high-bandwidth PCI local bus eliminates data bottlenecks found in traditional systems, maintains maximum performance at high clock speeds, and provides a clear upgrade path to future technologies.

The PCI bus contains two embedded PCI devices: the PCI local bus IDE interface and the PCI video/graphics controller. The PCI bus also contains a connector for attaching the bus expansion board.

Expansion Bus

The expansion bus contains one ISA slot, three PCI slots, one PCI/ISA slot, and one AGP video slot. The PCI ISA IDE Xccelerator chip (PIIX4) provides the logic that enables the ISA bus functions. With 24-bit memory addressing, a 16-bit data path, and an eight MHz clock, the ISA bus is designed to support all peripherals compatible with the IBM® AT™ standard. For PCI functions, the Xccelerator chip provides 32-bit memory addressing, 32-bit data path, and a 33-MHz clock speed.

BIOS

The BIOS (Basic Input Output System) is stored in the Intel PA28FB200BX Flash EPROM. The Flash EPROM is reprogrammable and allows fast, economical BIOS upgrades.

The system memory map is shown in Table 1-4.

Table 1-4 System Memory Map

Memory Address	Size	Function
100000-18000000	384 MB	Extended Memory
FC000-FFFFFF	16 KB	Boot Block
FA000-FBFFF	8 KB	ECSD (Plug and Play configuration and DMI)
F9000-F9FFF	4 KB	Reserved for BIOS
F8000-F8FFF	4 KB	OEM Logo or Scan User Flash
E8000-E7FFF	64 KB	POST BIOS
E0000-E7FFF	32 KB	POST BIOS (available as UMB)
C8000-DFFFF	96 KB	Available High DOS memory (open to ISA and PCI bus)
A0000-C7FFF	160 KB	Video memory and BIOS
9FC00-9FFFF	1 KB	Extended BIOS Data (movable by memory managers)
80000-9FBFF	127 KB	Extended conventional memory
00000-7FFFF	512 KB	Conventional memory

Plug and Play Support

The system comes with Plug and Play BIOS technology. Plug and Play eliminates complicated setup procedures for installing Plug and Play expansion boards.

To add a Plug and Play expansion board, simply power off the system, install the board, and power on the system. There are no jumpers to set and no system resource conflicts to resolve. Plug and Play automatically configures the board for the system. The system also supports non-Plug and Play boards.

Plug and Play is controlled by the Plug and Play BIOS and the system's operating system. The Plug and Play BIOS is stored in the Intel PA28FB200BX Flash EPROM on the system board.

The Plug and Play BIOS adds several steps to the POST process. During POST, the Plug and Play evaluates the configuration of installed boards and assigns available system resources to the devices. On completion of Plug and Play POST, the operating system checks to see if there are any additional resources required, then assigns available resources to the devices.

CMOS Memory/Real-Time Clock Battery

The 82371AB PCI ISA IDE Xcelerator (PIIX4) on the system board stores system information in non-volatile CMOS memory. The chip also contains the system's real-time clock. Both are maintained by a 3-volt coin cell lithium battery on the system board. The battery is replaceable.

DMA/IRQ Settings

The system automatically configures interrupts requests (IRQ), direct memory access (DMA) channels, and other parameters when adding PCI boards with minimal user intervention.

Table 1-5 and Table 1-6 list system IRQ and DMA default settings.

Table 1-5 Interrupt Level Assignments

IRQ	System Resource
NMI	I/O channel check
00	Reserved, internal timer
01	Reserved, keyboard buffer full
02	Reserved, cascade interrupt from slave PIC
03	COM2*
04	COM1*
05	LPT2 (Plug and Play option)/Audio/User available
06	Diskette drive
07	LPT1*
08	Real-time clock
09	Reserved
10	User available
11	Windows Sound System*/User available
12	Onboard mouse port (if present, else user available)
13	Reserved, math coprocessor
14	Primary IDE (if present, else user available)
15	Secondary IDE (if present, else user available)

* Default; setting can be changed.

Table 1-6 DMA Assignments

DMA	Resource
00	Audio
01	Audio/Parallel port
02	Diskette drive
03	ECP parallel port/Audio
04	Reserved, cascade channel
05	Available
06	Available
07	Available

IDE Ports

The system board provides two IDE ports:

- a fast IDE port (the primary channel)
- a standard IDE port (the secondary channel).

Each port supports two devices for a total of four IDE devices. The system board allows the connection of an IDE CD-ROM drive for system configuration flexibility without the addition of a controller.

The fast IDE port features an enhanced IDE interface which supports up to 10 MB per second 32-bit wide data transfers on the high-performance PCI local bus. (Standard IDE supports 2 MB to 3 MB per second on the ISA bus.) The standard hard disk and Zip drive (in some systems) are connected to the fast IDE port (primary channel) for high performance. The CD-ROM drive is attached to the standard IDE port (secondary channel).

I/O Ports

The system board features an enhanced parallel port, two buffered high-speed serial ports, and two Universal Serial Bus (USB) ports.

The enhanced parallel port supports Enhanced Capabilities Port (ECP) and Enhanced Parallel Port (EPP) modes for devices that require ECP or EPP protocols. These protocols allow high-speed bi-directional transfer over a parallel port and increase parallel port functionality by supporting more devices.

The two buffered high-speed serial ports use a fast 16550 UART which supports transfer rates up to 19.2 kilobytes (KB) per second. These ports allow the installation of high-speed serial devices for faster data transfer rates.

The two USB ports allow additional new plug and play serial devices without removing the system cover. Simply plug the USB device into the port. The speed varies between 12 megabits per second (Mbps) for printers and 1.5 Mbps for mice and keyboards. Up to 127 USB devices can be connected to the computer.

The combination of the enhanced parallel port, buffered serial ports, and USB ports ensure optimum performance for future peripheral devices and operating systems.

Sound System

The system board features Yamaha OPL[®] YMF715 audio chip. It integrates a 16-bit audio codec, OPL3 FM synthesis and DAC, 3D enhanced stereo controller, and an interface for MPU401 and a joystick. The chip also provides the following features.

- Stereo analog-to-digital and digital-to-analog converters
- Analog mixing, anti-aliasing, and reconstruction filters
- Support for 16-bit address decode
- ADPCM, A-law or μ law digital audio compression/decompression
- Full digital control of all mixer and volume control functions
- Sound Blaster[®] and Windows Sound System[™] compatibility

The system board provides connectors for the optional OPL4-ML wavetable synthesizer. The OPL4-ML integrates the OPL3 audio system, general MIDI processor and wavetable ROM. It provides FM synthesis and 24 distinct voices for music playback.

U.S. ROBOTICS MODEM BOARD (OPTIONAL)

Two modem boards are available: the U.S. Robotics[®] x2-capable Winmodem and the U.S. Robotics x2-capable Sportster. Each modem board contains fax and modem capabilities. The Winmodem provides fax and modem capabilities. The Sportster provides modem, fax, full-duplex speakerphone, and voicemail capabilities. Each board provides receive transfer rates of 56 Kbps (kilobytes per second) for data and 14.4 Kbps for fax.

DISKETTE DRIVE

The system comes standard with a 1.44-MB high-density diskette drive preinstalled in the 3 1/2-inch accessible device slot (drive A). The drive is connected to the system board via a two-connector cable.

HARD DISK DRIVE

The system supports up to three IDE hard drives, the standard hard drive, and two optional hard drives (if a Zip drive does not come standard with the system).

CD-ROM/DVD DRIVE

The drive can be used to load programs from a CD or it can be used to play audio CDs. The drive operates at different speeds depending on whether the CD contains music or data. The drive is fully compatible with Kodak Multisession Photo CDs™ and standard CDs.

The drive is connected to the secondary IDE/PCI port on the system board.

ZIP DRIVE

Some systems come with the Iomega® Zip 100 ATA drive. The Zip drive provides removable 100-MB data disks and has a data transfer rate up to 1.4 MB per second.

POWER SUPPLY

The 235-watt power supply is mounted inside the system unit. It supplies power to the system board, option boards, diskette drives, hard drives, keyboard, and mouse. A fan inside the power supply provides system ventilation. The power supply has several cables for attaching to the various devices requiring power.

POWER MANAGEMENT

The Advanced Power Management (APM) program, located on the 82371AB PCI ISA IDE Xcelerator (PIIX4) chip, reduces system power consumption when there is no activity detected from the keyboard, mouse, diskette drive, CD-ROM drive, or hard disk drive after a predefined period of time. As soon as activity is detected, the system resumes where it left off.

In the CMOS Setup utility, an inactivity timer is available for setting the length of time before the system enters a low-power mode.

Section 2

Setup Utility

This section describes the Setup utility program that allows the system configuration information to be viewed and changed.

NOTE: The system ships from the factory with the correct system parameters for the configuration. Unless setting the time and date, setting security features, customizing the system, or adding optional hardware, Setup does not need to be run.

CONFIGURATION INFORMATION

System configuration information is stored in nonvolatile memory. A nonvolatile memory device retains its data when system power is turned off.

Nonvolatile memory is a complementary metal-oxide semiconductor (CMOS) chip backed up by a battery on the system board. The battery supplies continuous power to CMOS memory and maintains configuration information when system power is off.

WHEN TO USE SETUP

The Setup utility allows the user to view and set system parameters. Use the Setup utility program:

- to set the time and date.
 - to update or check system parameters when adding or removing expansion options.
 - to change or set power management features.
 - to correct a hardware discrepancy when the Power-On Self-Test (POST) displays an error message and a prompt to run Setup.
 - to check the installation of optional memory by comparing the amount of memory installed with the amount of memory displayed by Setup.
 - to change certain system operating parameters, such as boot device sequence and keyboard parameters.
 - to configure system connections for peripherals such as the diskette drive, hard disks, and devices connected to the printer port and serial ports.
-

- to customize the system with security features such as passwords.
- to set system parameters after replacing the CMOS battery.

HOW TO START SETUP

To start the Setup utility, follow these steps:

1. Turn on or reboot the system.
2. Press **F2** after POST begins, but before the system boots up. You have about five seconds to press F2.

Setup's Main Menu window appears similar to the following screen.

NOTE: The screen shown is typical of a system. The actual settings on the Main Menu depend upon the hardware installed in the system.

BIOS Setup		
Main	Advanced	Security Power Boot Exit
Processor Type	Pentium® II	Item-Specific Help
Processor Speed	266 MHz	<Tab>, <Shift-Tab>, o
Cache RAM	512 KB	<Enter> selects field.
Total Memory	32 MB	
BIOS Version	xxxxxxxxxx	
Language:	[English (US)]	
System Time:	[13:48:18]	
System Date	[07/10/1997]	
>Floppy Options		
>Hard Disk Predelay	[Disabled]	
>Primary IDE Master	[XXXXXXXXXX]	
>Primary IDE Slave	[XXXXXXXXXX]	
>Secondary IDE Master	[None]	
>Secondary IDE Slave	[XXXXXXXXXX]	
F1 Help	↑↓ Select Item	-/+ Change Values
ESC Exit	←→ Select Menu	F9 Defaults for Page
	Enter Select	> Sub-Menu F10 Previous Values

HOW TO USE SETUP

The Setup utility has a Main Menu window and five top-level menus with submenus.

The Main Menu window contains the following areas:

- A title line — the top line of the Main Menu. This line displays the Setup utility name and copyright message.
- The menu bar — the line under the Setup title line. The menu bar contains five top-level menus to set system parameters.
- A Main Menu summary window — the area on the left side of the screen. This area provides a summary of Main Menu Setup parameters. Some Main Menu parameters can be set from this window or they can be set from submenus.
- The help and navigation window — the area on the right side of the screen. This area provides help information for the Setup option currently selected. The navigation keys provide a summary of commands available for making selections.
- The General Help window — a window that appears any time during Setup after pressing **F1**. This help window provides general information about using Setup.

The following subsections describe how to use the Main Menu window to set system parameters.

Menu Bar

The menu bar at the top of the Main Menu window lists these menus:

- **Main** — Use the Main menu for basic system configuration. For example, select “Main” to set the system time, system date, diskette drive, and hard drive parameters. Use this menu to check memory parameters.
- **Advanced** — Use the Advanced menu to set serial port and printer port addresses and interrupts, and to enable/disable the system’s IDE and diskette drive interfaces.

The Advanced menu also provides submenu items for setting keyboard features, video configurations, and DMI event logging.

- **Security** — Use this menu to set User and Supervisor Passwords and the Unattended Start feature.
 - **Power** — Use the Power menu to set power management parameters.
 - **Boot** — Use this menu to set boot options.
 - **Exit** — Exits the Setup utility with various save or discard options.
-

A Maintenance Menu appears when the system is in configure mode. See Appendix C for information on putting the system in configure mode. This menu allows you to change the processor speed and to clear user and supervisor passwords.

To select an option from the menu bar, use the left and right arrow keys. See “Exiting Setup” in this section for a description on exiting the Main Menu.

Legend Bar

Use the keys listed in the legend bar on the bottom of the Setup menu to make the selections or exit the current menu. Table 2-1 describes the legend keys and their alternates.

Table 2-1 Setup Key Functions

Key	Function
F1	Provides help for the parameter field being displayed.
Esc	Exits the menu.
← or → arrow keys	Selects next menu.
↑ or ↓ arrow keys	Moves cursor up and down for item selection.
Enter	Executes a command or selects submenu.

Selecting a Menu Item

To select a menu item, use the up/down arrow keys to move the cursor to the desired field. Then press **Enter**. The Exit Saving Changes command in the Exit Menu saves the values currently displayed in all the menus.

Displaying a Submenu

To display a submenu, use the up/down arrow keys to move the cursor to the desired submenu. Then press **Enter**. A pointer (a right-pointing triangle) marks all selectable submenus.

Getting Help

A Field Help window or Item Specific Help window on the right side of each menu displays the help text for the currently selected Setup option. It updates as the cursor moves to each new field.

Pressing **F1** on any menu brings up the General Help window that describes the legend keys and their functions.

Press **Esc** to exit the current window.

MAIN MENU

This section describes the Main Menu parameters. Other menu parameters are available by selecting submenus. Use the arrow keys to move the cursor to a parameter and press **Enter** to select a submenu. Items with lighter text are not available.

- Processor Type

This field displays your computer's processor type.

- Processor Speed

This field displays your processor's speed.

- Cache RAM

This field displays the size of your system's L2 (external) cache.

- Total Memory

This field displays the total amount of memory installed on your system board.

- BIOS Version

This field displays your system's BIOS version number.

- Language

This field displays the current default language used by the BIOS. Depending on the system you purchased, you may choose a different display language from among the options listed below.

- English (US) (default)

- Italiano

- Français

- Deutsche

- Español

- System Time and Date

These two fields specify the correct time and date. To change them, press **Tab** to highlight the field you want to change, then press the + or – keys to change the setting.

- Hard Disk Predelay

This option keeps BIOS from searching for a drive until the specified predelay time has passed. This allows certain drives time to spin up before being detected by the BIOS.

Floppy Options Submenu

This submenu can be used to configure your system's floppy disk drives. To enter the submenu, highlight the Floppy Options field, then press **Enter**. You'll see the following options:

- Diskette A:/B:

These fields specify the capacity and physical size of Diskette Drive A and B (if included). To change these, highlight the field for the drive, press **Enter** and select from the following options:

- Disabled
- 360KB, 5.25 inch
- 1.2MB, 5.25 inch
- 720KB, 3.5 inch
- 1.44/1.25 MB, 3.5 inch (default for Drive A)
- 2.88 MB, 3.5 inch.

If you add an optional 5.25-inch diskette drive to your system, select Floppy B and change the parameter to 1.2 MB, 5.25 inch.

- Floppy Write Protect

This option enables or disables write protection for the diskette drive(s). Choose the desired setting to enable or disable (default) this option.

To return to the Main Menu, press **Esc**.

- IDE Devices

The next four entries, Primary IDE Master and Slave, and Secondary IDE Master and Slave refer to settings for IDE devices. These fields report the presence of, and identification for as many as four physical IDE devices, two on each PCI/IDE connector.

The submenus can be used to auto-configure or manually configure the IDE devices, usually hard drives or CD-ROM drives. Depending on the system you purchased, the available options may include “User,” “Auto” (default), “CD-ROM,” “IDE Removable,” “ATAPI Removable” or “None.”

The standard hard drive (drive C) shipped with the system is configured as “Primary IDE Master.” The standard CD-ROM drive is configured as “Secondary IDE Master.” When the cursor is placed on one of these fields and selected by pressing **Enter**, the IDE Device submenu appears allowing the drive parameters to be set.

NOTE: Jumpers on the IDE device must be set to the master or slave device (see the documentation that comes with the device).

Primary/Secondary IDE Master/Slave Submenus

These entries let you check or change the following hard disk drive parameters. They are not available if “Auto” is selected.

- Cylinders/Heads/Sectors fields

Cylinders — If your device configuration type is set to “Auto,” this field displays the number of cylinders for your hard drive and cannot be changed. If the Type is set to “User,” you must enter the correct number of cylinders for your hard drive.

Heads — If your device configuration type is set to “Auto,” this field displays the number of heads for your hard drive and cannot be changed. If the Type is set to “User,” you must enter the correct number of heads for your hard drive.

Sectors — If your device configuration type is set to “Auto,” this field displays the number of sectors for your hard drive and cannot be changed. If the Type is set to “User,” you must enter the correct number of sectors for your hard drive.

Maximum Capacity — This field displays the maximum capacity of your hard disk drive, a value based on the number of cylinders, heads and sectors.

■ Multi Sector Transfers

This option determines the number of sectors per block for multiple sector transfers. Like the Cylinders/Heads/Sectors options discussed above, you cannot access this option if the configuration type is set to “Auto.” If necessary, check the specification for your hard drive to determine the best setting for optimum drive performance. The options include:

- 2 Sectors
- 4 Sectors
- 8 Sectors
- 16 Sectors (default)
- Disabled.

■ LBA Mode Control

This option specifies the IDE translation mode. LBA causes Logical Block Addressing to be used in place of Cylinders/Heads/Sectors. You can “Enable” (default) or “Disable” this option. This option cannot be changed when “Auto” is selected.

WARNING: Don't change the translation mode setting from the option selected when the hard drive was formatted. Changing the option after formatting could result in corrupted data!

■ 32 Bit I/O

This option enables (default) or disables 32-bit IDE data transfers between the processor and the IDE device.

■ Transfer Mode

This option determines the method for transferring data between the hard drive and system memory. This option cannot be changed when “Auto” is selected. The options include:

- Standard
 - Fast PIO 1
 - Fast PIO 2
 - Fast PIO 3
 - Fast PIO 4 (default).
-

- Ultra DMA

This option sets the Ultra DMA Mode for the hard drive. This option cannot be changed when “Auto” is selected. The options include:

- Mode 0
- Mode 1
- Mode 2
- Disabled (default).

To return to the Main Menu, press **Esc**. To move to the Advanced Menu, press the right arrow key.

ADVANCED MENU

This section describes the Advanced Menu parameters. Other menu parameters are available by selecting submenus. Use the arrow keys to move the cursor to a parameter and press **Enter** to select a submenu. Items with lighter text are not available.

- Plug & Play O/S

This option lets you specify whether a Plug and Play-compatible operating system is being used in your system. Choose “Yes” (default) or “No.”

- Reset Configuration Data

This option clears the BIOS configuration data on the next boot. The options include “No” (default) or “Yes.”

- Memory Cache

This option sets the state of the memory cache. The options include “Enabled” (default) or “Disabled.”

Resource Configuration Submenu

This option allows you to reserve specific resources for use by legacy ISA devices. To enter the submenu, highlight this field, then press **Enter**. The following options are displayed:

- Memory Reservation Submenu

This option lets you reserve specific upper memory blocks for use by legacy ISA devices. When selected, the submenu displays a lists of addresses from which specific addresses can be selected. Use the arrow (cursor) keys to highlight an upper memory block, then press **Enter**. Select “Available” (default) or “Reserved” with the cursor keys, then press **Enter** to change the setting.

To return to the Resource Configuration submenu, press **Esc**.

- IRQ Reservation Submenu

This option lets you reserve specific IRQs (interrupt requests) for use by legacy ISA devices. To do so, highlight this field, then press **Enter**. Use the arrow (cursor) keys to highlight the specified IRQ, then press **Enter**. Select “Available” (default) or “Reserved” with the arrow keys, then press **Enter** to change the setting.

WARNING: An asterisk symbol appearing next to an option indicates that the selected IRQ is set to conflict with another device.

To return to the Advanced Menu, press **Esc** twice.

Peripheral Configuration Submenu

This submenu can be used to configure your system’s ports or peripheral devices. To enter the submenu, highlight this field, then press **Enter**. The following options appear:

- Serial Port A/Serial Port B

These options let you configure your system’s Serial Port A or Serial Port B. You can choose “Auto” (default), “Enabled” or “Disabled.” The “Auto” setting causes the Setup program to assign the first free COM port (for example, COM 1 3F8h, IRQ4 or COM2, 2F8h, IRQ3). Note that if you set a specific serial port address, it does not appear in the list of options for the other serial port.

WARNING: An asterisk symbol appearing next to an option indicates that the selected IRQ is set to conflict with another device.

NOTE: If you select the Enabled option, you can see additional options that allow you to specify the Base I/O address and IRQs for the port you are configuring.

■ Mode (Serial Port B)

If installed, this option sets the mode for “Serial Port B” to “Normal.”

■ Parallel Port

This option configures the system’s Parallel Port. Choose “Auto” (default), “Enabled” or “Disabled.” The “Auto” setting causes the Setup program to assign LPT 1, 378h, IRQ7.

NOTE: If you select the Enabled option, you can see additional options that allow you to specify the Base I/O address and IRQs for the port you are configuring.

■ Mode (Parallel Port)

This option sets the mode for the Parallel Port. The options include “Output Only” (AT-compatible mode), “Bidirectional” (PS/2-compatible mode), “EPP” (Extended Parallel Port – high speed bidirectional) and “ECP” (Enhanced Capabilities Port – high speed bidirectional).

WARNING: An asterisk symbol appearing next to an option indicates that the selected IRQ is set to conflict with another device.

To return to the Resource Configuration submenu, press **Esc**. Then press **Esc** a second time to return to the Advanced Menu.

- Floppy Disk Controller

This option configures the system's diskette drive controller. Select "Enabled" (default) or "Disabled."

- IDE Controller

This option configures the system's integrated IDE controller. Select from "Primary," "Secondary," "Both" (default) or "Disabled."

To return to the Advanced Menu, press **Esc**.

Keyboard Configuration Submenu

This submenu is used to configure specific keyboard features. To enter the submenu, highlight this field, then press **Enter**. The following options appear:

- NumLock

This option controls whether the NumLock key on the keyboard is on or off at boot-up. The choices are "Auto" (default), "On" or "Off."

- Key Click

This feature enables or disables the key click option. Select "Enabled" or "Disabled" (default).

- Keyboard Auto-Repeat Rate

This feature selects the key repeat rate, the rate at which a key, when pressed and held, repeats itself. The eight options range from 30 per second (default) to 2 per second.

- Keyboard Auto-Repeat Delay

This feature selects the delay before key repeats. The four options include from ¼ second to 1 second. The default is ½ second.

To return to the Advanced Menu, press **Esc**.

Video Configuration Submenu

This submenu can be used to configure specific video features. To enter the submenu, highlight the field, then press **Enter**. The following option appears:

- Palette Snooping

This option controls the ability of a primary PCI graphics controller to share a common palette with an ISA add-in video board. Select “Enabled” or “Disabled” (default).

To return to the Advanced Menu, press **Esc**.

DMI Event Logging Submenu

This submenu can be used to view and modify DMI Event Logs. To enter the submenu, highlight the DMI Event Logging field, then press **Enter**. The following options appear:

- Event Log Capacity/Event Log Validity

These fields indicate whether space is available in the Event Log, and whether the contents of the log are valid.

- View DMI Event Log

If there are no event logs stored, you cannot access this log.

- Clear All DMI Event Logs

This option clears the DMI Event Log after rebooting the system. Choose “No” (default) or “Yes.”

- Event Logging

This option enables logging of DMI Events. Choose “Disabled” or “Enabled” (default).

- Mark DMI Events as Read

This option is used to mark off all DMI Events as read. If necessary, press **Enter** to access the Confirmation dialog box and confirm your preference.

To return to the Advanced Menu, press **Esc**. Then press the right arrow (cursor) key to move to the Security Menu.

SECURITY MENU

The Security Menu can be used to set a user password and/or a supervisor password.

A User Password controls access to the system and Setup Utility program at boot up. If the User Password feature has been enabled, you need to enter your User password correctly whenever you boot the system before you can use it.

A Supervisor Password controls access to the BIOS and Setup Utility program. If the Supervisor Password feature has been enabled, a Supervisor password must be entered correctly before all options in the Setup Utility program are available (for example, to disable password protection).

Press the right arrow (cursor) key to move to the Power Menu.

POWER MENU

The Power Menu can be used to enable or disable the system's power management features. When the power management option is enabled, the following options appear in the Power Menu:

- Power Management

This feature lets you enable or disable BIOS power management.

- Inactivity Timer

The Inactivity Timer lets you set the length of time that the system needs to be inactive before entering its low-power mode. The low-power mode powers down various devices in the system until you resume using it. You can select from "Off," "1," "2," "4," "6," "8," "12" or "16 minutes." A setting of 1 minute achieves maximum power savings, while a setting of 16 minutes allows maximum performance.

- Fixed Disk

This option controls whether or not a spin down command is issued to the hard drives when the system goes into a low-power mode. Your choices are "Enabled" (default) or "Disabled."

- VESA Video Power Down

This option controls power to the monitor during the low-power modes. Your choices are "Disabled" or "Enabled."

Press the right arrow (cursor) key to move to the Boot Menu.

BOOT MENU

The Boot Menu can be used to adjust the system's boot features. The Boot Menu features the following options:

- Restore on AC/Power Loss

This option specifies whether or not to restore power to the computer if it is turned on and there is a power failure. The options are "Stay Off" which keeps the power off, "Power On" (default) which restores the system's power, and "Last State" which restores the previous power state.

- On Modem Ring

This option specifies how the system responds when power is off and the modem detects an incoming call. The options are "Stay Off" (default) and "Power On."

- On LAN

This option controls how the system responds to a LAN wake-up call. The options are "Stay Off" (default) and "Power On."

- On PME

This option controls how the system responds to a PCI power management event. The options are "Stay Off" (default) and "Power On."

- First/Second/Third/Fourth Boot Device

You can select the sequence of boot devices by type. Pressing your keyboard's + (plus) or - (minus) key allows you to select the order. For maximum system accessibility, Removable Device should always be set as the First Boot Device.

Hard Drive Submenu

This submenu lists the system's available hard drives. Your computer tries to boot to the operating system on the first device listed on the Hard Drive submenu. If no operating system is found, the system continues trying the drives in the order they are listed until an operating system is located.

To see a list of available drives, highlight this field and press **Enter**. You can select the boot device by pressing your keyboard's + or - key. To exit from the Hard Drive submenu, press **Esc**.

Removable Drive Submenu

This submenu lists any available removable drives (if included). One common option is Legacy Floppy Drives. The operating system assigns drive letters to these devices in the order listed. You can change the sequence (and drive lettering) by highlighting this field and pressing **Enter**. Then press your keyboard's **+** or **-** key to move a device up or down the list. To exit from the Removable Drive submenu, press **Esc**.

Press the right arrow (cursor) key to move to the Exit Menu.

EXIT MENU

The Exit Menu allows you to choose how to exit the Setup program. Press the arrow (cursor) keys to select the desired option, then press **Enter** to make your choice (or use the arrow key to select another one).

- Exit Saving Changes

This option exits the Setup program and saves your changes to the BIOS.

- Exit Discarding Changes

This option exits the Setup program without saving your changes to the BIOS.

- Load Setup Defaults

This option loads the Setup program's default values.

- Load Custom Defaults

This option loads Custom default settings.

- Save Custom Defaults

This option saves your changes to Custom default settings.

- Discard Changes

This option loads previous values from CMOS RAM for all BIOS settings.

NOTE: If your system's CMOS fails, the BIOS will load custom default settings (if you've saved them) or factory default settings.

Finally, press **Enter** again to confirm and exit the Setup program.

Section 3

Option Installation

This section provides instructions for installing the following options:

- expansion boards
- DIMM memory upgrade
- video upgrade — see the documentation for your video board
- data storage devices
- external options.

All options (except external options) require the removal of the access cover. Procedures for removing the cover are included in this section.

GENERAL RULES FOR INSTALLING OPTIONS

Follow these general rules when installing system options.

- Turn off system power and unplug the power cable.
 - Turn off and disconnect all peripherals.
 - When handling boards or chips, touch the metal of the system unit to discharge static.
 - Do not disassemble parts other than those specified in the procedure.
 - Use a Phillips-head screw driver, unless otherwise specified.
 - Label any removed connectors. Note where the connector goes and in what position it was installed.
-

PRECAUTIONS

Take care when working inside the system and when handling computer components. Avoid electric shock or personal injury by observing the following warning.

WARNING: Before removing the access cover, turn off the power and unplug the system power cable. Power is removed only when the power cable is unplugged.

Static electricity and improper installation procedures can damage computer components. Protect computer components by following these safety instructions.

CAUTION: Electrostatic discharge can damage computer components. Discharge static electricity by touching a metal object before removing the access cover.

- Avoid carpets in cool, dry areas. Leave an option, such as a board or chip, in its anti-static packaging until ready to install it.
- Dissipate static electricity before handling any system components (boards, chips, etc.) by touching a grounded metal object, such as the system's unpainted metal chassis.

If possible, use anti-static devices, such as wrist straps and floor mats.

- Always hold a chip or board by its edges. Avoid touching the components on the chip or board.
- Take care when connecting or disconnecting cables. A damaged cable can cause a short in the electrical circuit. Misaligned connector pins can cause damage to system components at power-on.

When installing a cable, route the cable so it is not pinched by other components and is out of the path of the system unit cover. Prevent damage to the connectors by aligning connector pins before you connect the cable.

- When disconnecting a cable, always pull on the cable connector or strain-relief loop, not on the cable.
-

REMOVING THE ACCESS COVER

The following subsections describe how to remove the access cover from the desktop or minitower system.

WARNING: Before removing the access cover, turn off the power and unplug the system power cable. Power is removed only when the power cable is unplugged.

1. Turn off the computer.
2. Disconnect the keyboard, mouse, monitor, and any other external options (such as a printer) from the rear of the computer.

Label all cables to make reinstallation easier.

CAUTION: Electrostatic discharge can damage computer components. Discharge static electricity by touching a metal object before you remove the system access cover.

3. If the system is a minitower, lay the system down on its right side.
4. Loosen the thumb screw at the rear of the system by turning it counterclockwise. If you installed a lock on the back of the system, unlock the lock and remove it.

Press the right release tab. While pressing the tab, push down and back on the right rear of the cover. The cover slides back about 1/2 inch.

Press the left release tab. While pressing the tab, push down and back on the left rear of the cover. The cover slides back about 1/2 inch.



Figure 3-1 Releasing the Cover

5. Lift the access cover off the system.

REPLACING THE ACCESS COVER

To replace the access cover, use the following procedure.

1. Gently set the access cover inside the edge of the case, taking care not to bend the metal tabs.
2. Align the tabs on the access cover with their corresponding slots on the system.

Insert the tabs on the edge of the access cover into their slots on the system.



Figure 3-2 Aligning the Tabs

3. Slide the access cover forward to meet the front panel.
4. Tighten the thumb screw.

NOTE: The cover fits tightly. If it does not slide all the way to the front panel, place one hand on the front of the unit while you slide the cover forward from the rear.

5. Reconnect all external peripherals.
6. Plug in power cables.

EXPANSION BOARDS

Your computer's system board features several expansion slots that can accommodate accessory adapter boards, such as a sound board or TV board. Depending on the system you purchased, some of these devices may be installed in your system.

The Direction Series supports ISA Plug and Play expansion boards. Plug and Play allows the installation of a board in an expansion slot without changing the hardware settings. There are no system resource conflicts to resolve. Plug and Play automatically configures the board for the system.

Industry-standard 8-bit and 16-bit ISA, and 32-bit PCI expansion boards are supported in the system unit. ISA expansion boards can be Plug and Play or non-Plug and Play boards.

PCI expansion boards run at one half the system host's bus speed. The PCI bus handles 32 bits of data at a time, being wider as well as faster than the standard ISA bus. PCI boards can send and receive data much faster, thereby boosting system performance.

Expansion Slot Locations

Your system has six expansion slots:

- one ISA slot
- three PCI slots
- one shared ISA/PCI slot
- one AGP slot.

The following figure shows expansion slot locations.



Figure 3-3 Locating Expansion Slots

Expansion Board Installation

Install expansion boards in the system as follows.

1. Remove the access cover.
2. Follow any preinstallation instructions that come with the expansion board (such as setting switches or jumpers on the board).
3. Remove the screw securing an expansion slot cover and remove the cover.

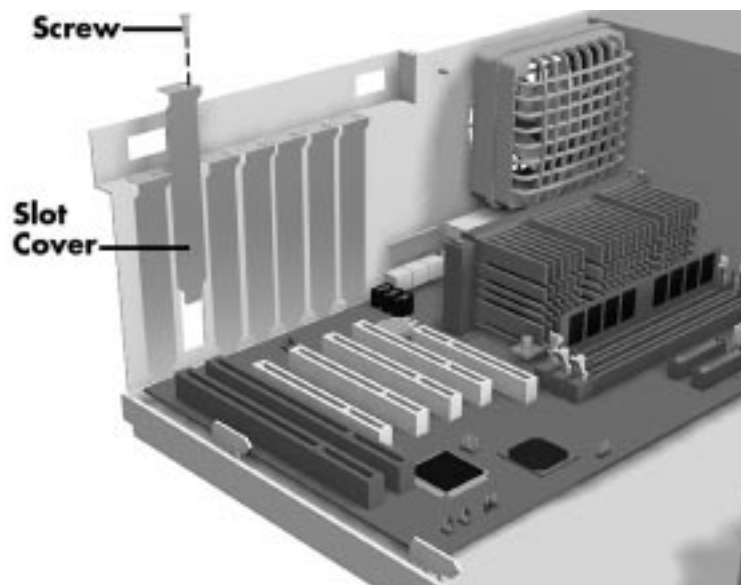

Figure 3-4 Removing the Slot Cover

Save the screw for installing the expansion board. Be sure to save the slot cover for future use.

CAUTION: A slot cover can damage the system board or any option board if it falls into the system. Take care to keep the slot cover from falling when removing the screw.

If the slot cover does fall into the unit, remove it before replacing the cover.

4. Hold the board by its edges and insert it into the expansion slot.
5. Press the board firmly into the expansion slot connector. Gently rock the board from side-to-side to seat it into the connector.
6. Insert the screw removed earlier to secure the expansion board to the support bracket.
7. Attach any cables required by the expansion board.
8. Replace the access cover.

Expansion Board Removal

1. Remove the system access cover.
2. Label and remove any cables connected to the board.
3. Remove the screw that secures the board to the support bracket.
4. Pull the board out of the connector. Gently rock the board from side-to-side to release it from its connector.
5. Replace the access cover.

DIMM UPGRADE

Depending on the model, your system comes factory-installed with 32 MB to 192 MB of main system memory, as three 168-pin sockets on the system board for Dual In-line Memory Modules (DIMMs).

You may install memory in one, two, or three sockets and the size and speed may vary between sockets. Single- and double-sided DIMMs are supported.

Depending on product upgrade availability, your system memory can be upgraded to a total of 384 MB. When upgrading your system memory, note the following conditions:

- Be sure to use 168-pin 3.3V DIMMs with gold-plated contacts.
 - Bus speed of 66 MHz only is supported.
-

- Non-Error Correcting and Checking (64-bit) and ECC (72-bit) DIMMs are both supported. When ECC memory is installed, the BIOS automatically detects its presence and offers the Setup option to enable ECC mode.

NOTE: Although memory size and type may vary, the SDRAM DIMMs must meet the Intel 4-clock, 66-MHz, unbuffered SDRAM DIMM specification for either 64-bit or 72-bit SDRAM.

Use the following procedure to:

- Check the memory installed in the system
- Determine the DIMM configuration needed to increase memory
- Identify DIMM sockets.

NOTE: If any cables block access to the DIMM sockets, label and disconnect them. If any boards block access to the sockets, remove them.

1. Locate the three DIMM sockets, J7J1 – Bank 0, J6J2 – Bank1, and J6J1 – Bank 2. See Appendix B to identify the sockets.
2. Use the following table to determine the DIMM configuration needed to upgrade memory.

Table 3-1 Sample Memory Configurations

Bank 0	Bank 1	Bank 2	Total RAM
1 M x 64 (8 MB)	Empty (0 MB)	Empty (0 MB)	8 MB (min. memory)
Empty (0 MB)	4 M x 64 (32 MB)	8 M x 64 (64MB)	96 MB
16 M x 64 (128 MB)	Empty (0 MB)	2 M x 64 (16 MB)	144 MB
2 M x 72 (16 MB)	2 M x 72 (16 MB)	4 M x 72 (16 MB)	64 MB (ECC)
2 M x 64 (16 MB)	Empty (0 MB)	2 M x 64 (16 MB)	32 MB
4 M x 64 (32 MB)	4 M x 64 (32 MB)	8 M x 64 (64 MB)	128 MB
8 M x 64 (64 MB)	1 M x 64 (8 MB)	4 M x 64 (32 MB)	104 MB
2 M x 64 (16 MB)	4 M x 64 (32 MB)	1 M x 64 (8 MB)	56 MB
4 M x 64 (32 MB)	8 M x 64 (64 MB)	2 M x 64 (16 MB)	112 MB
Empty (0 MB)	16 M x 72 (128 MB)	16 M x 72 (128 MB)	256 MB (ECC)
16 M x 64 (128 MB)	2 M x 64 (16 MB)	8 M x 64 (64 MB)	210 MB
16 M x 64 (128 MB)	4 M x 64 (32 MB)	8 M x 64 (64 MB)	224 MB
16 M x 72 (128 MB)	8 M x 72 (64 MB)	1 M x 72 (8 MB)	200 MB (ECC)
16 M x 64 (128 MB)	16 M x 64 (128 MB)	16 M x 64 (128 MB)	384 MB
16 M x 72 (128 MB)	16 M x 72 (128 MB)	16 M x 72 (128 MB)	384 MB (ECC)

DIMM Removal

Use the following procedure to remove a DIMM.

CAUTION: Reduce static discharge by touching the system's metal chassis.

1. Remove the access cover.
2. Locate the DIMM sockets.
3. To remove a DIMM from its socket, press the plastic clips at the outer edges of the socket away from the DIMM.
4. Carefully rock the DIMM to pull it from the socket.

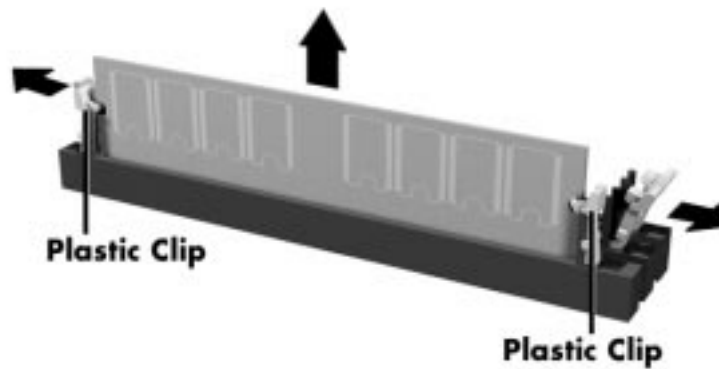

Figure 3-5 Removing a DIMM

5. Store the DIMM in an antistatic bag (available at electronic supply stores) or a cardboard box.

DIMM Installation

Use the following procedure to install a DIMM.

1. Remove the access cover.
2. Locate the DIMM sockets.
3. Remove any currently-installed DIMMs that are not needed. See “DIMM Removal” in this chapter.

CAUTION: Before installing a DIMM, reduce static discharge by touching the system’s metal chassis.

4. To install a DIMM, align the module with an empty socket. Make sure that the notches on the DIMM line up with the keys in the sockets.
5. Insert the DIMM into the socket. Close the plastic clips at both ends of the socket.

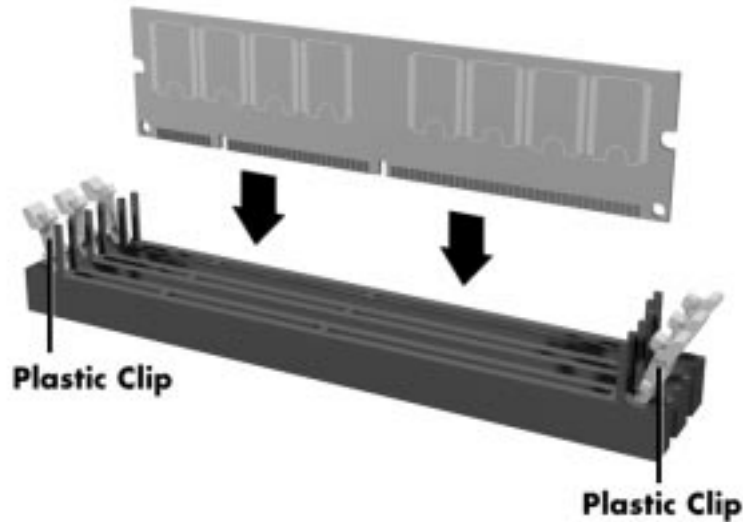

Figure 3-6 *Installing a DIMM*

6. Replace any cables or boards that may have been removed.
7. Replace the access cover.

VIDEO UPGRADE

Your computer comes with an AGP video board.

See your video board's documentation for information on upgrade capabilities.

DATA STORAGE DEVICES

The system board in your computer supports the following storage devices:

- two diskette drives, including the standard 1.44-MB diskette drive and a tape backup unit
- up to four IDE drives.

Device Slots

Your computer has seven storage device slots:

- a 3.5-inch accessible device slot (contains the standard 1.44-MB diskette drive)
 - two internal 3.5-inch hard drive slots (one contains the hard drive)
-

- four accessible device slots
 - two accessible 5.25-inch device slots (one contains the standard CD-ROM drive)
 - two 3.5-inch device slots; the lower 3.5-inch slot is not accessible on the desktop model.

Figure 3-7 shows the device slot locations in the system.

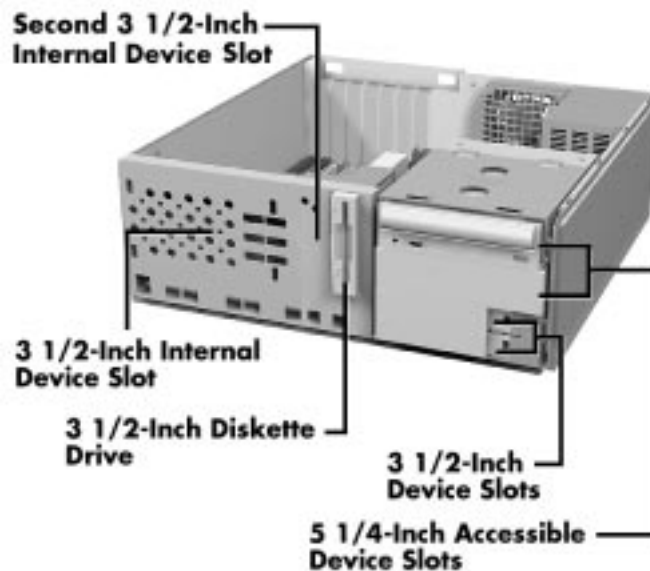

Figure 3-7 *Locating Device Slots*

Device Preparation

Before installing a storage device in the system, follow any preinstallation instructions that come with the device. For example, check the following:

- Diskette drive — remove any termination jumpers on the optional diskette drive. See the documentation that comes with the drive.
 - IDE device — check the jumper settings on the device before installing it. See the documentation that comes with the device for jumper setting information.
 - An IDE device, such as an IDE hard disk or IDE CD-ROM drive, must be set correctly as the first (master) or second (slave) device on the IDE channel.
 - The standard IDE hard disk is set as the master device on the primary IDE connector. The standard CD-ROM drive is the master device on the secondary IDE connector.
-

- SCSI device — The last SCSI device connected to the system (internally or externally) must have a termination resistor, either installed manually or set automatically if the device is self-terminating. Check the manufacturer's documentation.
- Installation hardware — check to be certain you have the screws necessary to secure the drive in an accessible drive slot.

Device Cables

The cables used for the installation of optional storage devices include:

- diskette drive signal cable
- IDE signal cables
- system power cables.

The addition of a diskette drive might require the replacement of the existing diskette drive cable. The addition of an IDE device does not require the replacement of the existing IDE cable. The existing IDE cables support two devices on each cable.

Cable connector locations are shown in Figure 3-8.

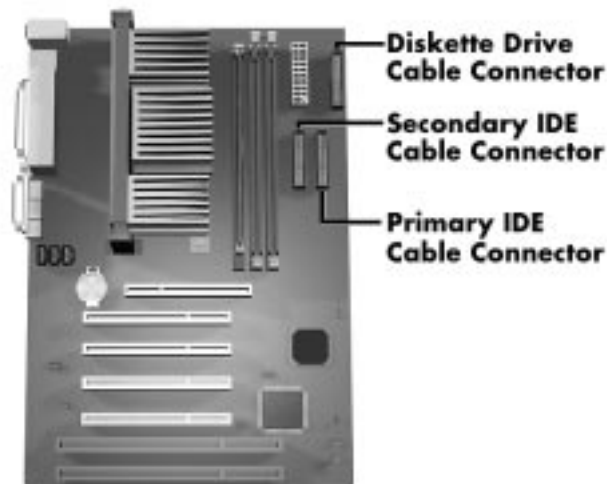

Figure 3-8 System Board Cable Connectors

Diskette Drive Signal Cable

A two-connector diskette drive signal cable comes attached to the system board and to the standard 1.44-MB diskette drive. If your system comes standard with an Iomega Ditto tape backup unit, the signal cable has three connectors.

Depending on the model, installation of a second 5 1/4-inch accessible device may require the replacement of the existing diskette drive signal cable with a three-connector cable. Connect an optional device to the middle connector on the three-connector diskette drive signal cable.

The colored edge of the cable goes to pin 1 on the cable connector. Align the red edge of the cable with pin 1 (the notched end) on the drive connector.

Figure 3-9 shows a three-connector diskette drive signal cable.

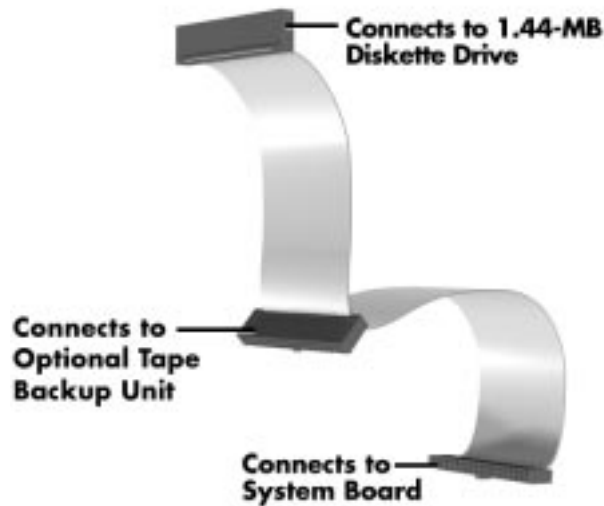

Figure 3-9 Diskette Drive Signal Cable

IDE Signal Cables

Each system comes with a three-connector IDE interface cable attached to the primary IDE connector and the installed hard disk. A second IDE cable connects to the CD-ROM drive and to the secondary IDE connector. In some systems, a Zip drive also comes attached to the primary IDE cable.

Figure 3-10 shows a typical three-connector IDE cable. If the IDE cable is not keyed with a connector tab, align the colored edge of the cable with the pin 1 side of the drive connector.

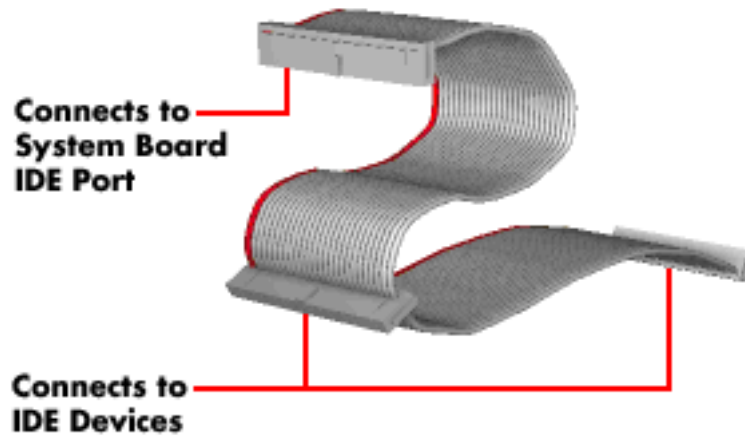

Figure 3-10 IDE Signal Cable

System Power Cables

Power cables come from the power supply and are attached to the standard storage devices. System power cables vary in length and provide connector sizes to accommodate a variety of supported storage configurations.

Power cable connectors are keyed to fit only in the correct position. Figure 3-11 shows the power cable connectors.

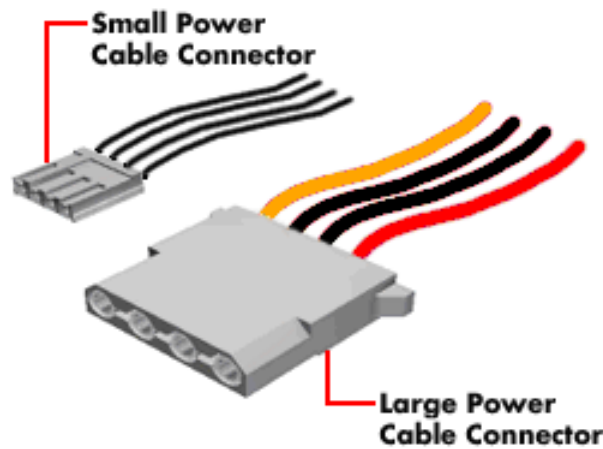

Figure 3-11 Power Cable Connectors

Device Cabling

All storage devices require a power and signal cable connection. Devices shipped with the system are already connected. Cable optional devices as follows.

Cabling an IDE Device

1. Connect the IDE signal cable connector to the connector on the IDE device.
Take care to prevent bending drive connector pins. Align the IDE cable connector as shown in Figure 3-12.
2. Locate an available power connector coming from the power supply.
3. Connect the appropriate power cable to the power connector on the IDE device.

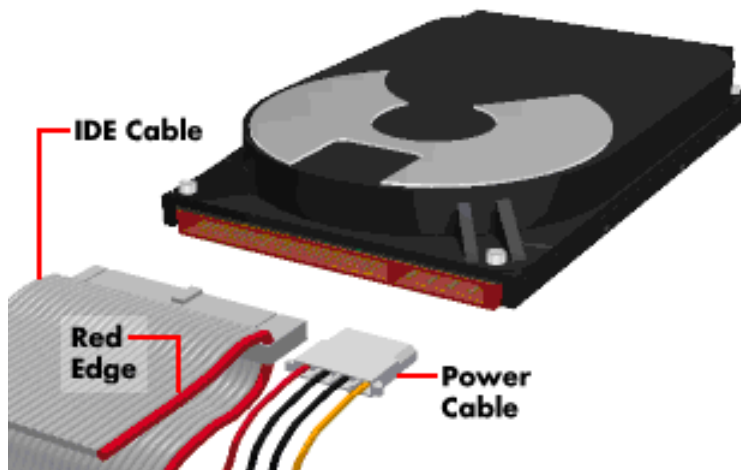

Figure 3-12 *Connecting IDE Device Cables*

4. If installing an IDE CD-ROM drive, also connect the audio cable (see the instructions that come with the drive).

Cabling an Accessible 5 1/4-Inch Device

1. Connect the diskette drive signal cable connector to the signal connector on the device (see Figure 3-13).
2. Locate an available power connector.
3. Connect the power cable to the power connector on the device.

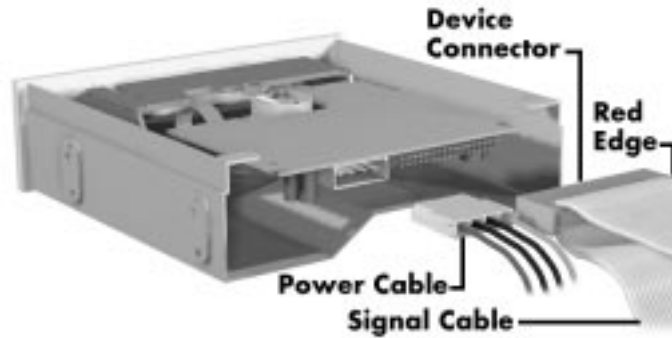

Figure 3-13 Connecting an Accessible 5 1/4-Inch Device

Storage Device Installation

The following subsections describe how to install 3 1/2-inch and 5 1/4-inch devices. The installation procedures include:

- removing the front panel
- removing the CD-ROM/DVD drive
- installing a 3 1/2-inch device
- installing a 5 1/4-inch device
- replacing the front panel.

Removing the Front Panel

Use the following procedure to remove the front panel.

1. Locate the two plastic tabs at the front of the chassis. They are indicated by two arrows engraved on the chassis.
2. Press down on the two tabs and press in a third tab at the end of the panel to release the panel (see Figure 3-14).

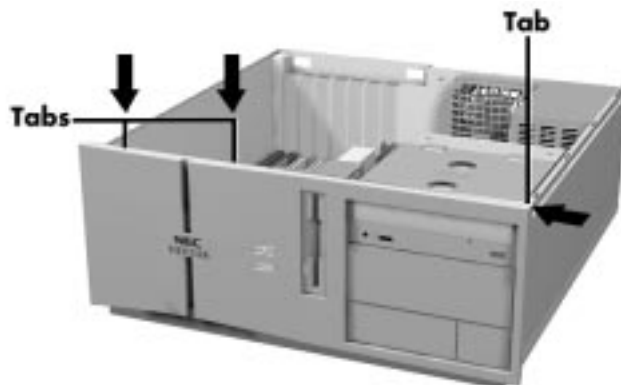

Figure 3-14 *Releasing the Front Panel*

3. Pull the panel away from the chassis.

Removing the CD-ROM/DVD Drive

If you need to remove the CD-ROM/DVD drive, you need to remove the accessible device cage.

Use the following procedure to remove the accessible device cage.

1. Locate the screw on the front of the system between the 3.5-inch blank panel and diskette drive. Remove the screw.

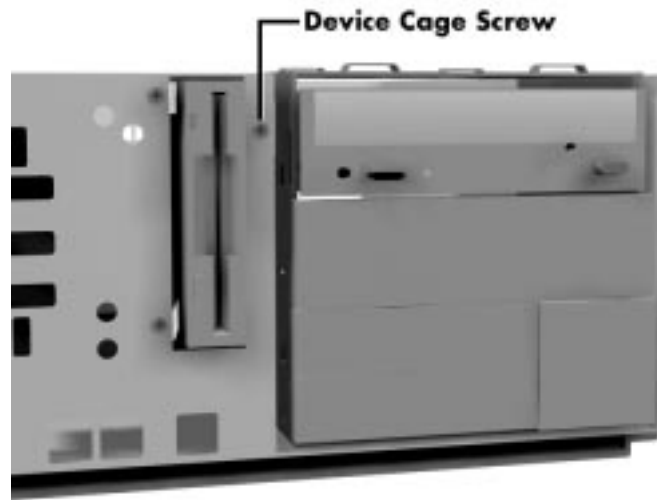

Figure 3-15 *Removing the Device Cage Screw*

2. Slide the cage towards the front of the system and lift it out of the unit.

Installing a 3 1/2-Inch Device

Use the following procedure to install a 3 1/2-inch device.

1. Follow the preinstallation instructions that came with the device, such as setting jumpers and switches.
 2. Remove the access cover.
 3. Remove and label any cables that interfere with installing the device.
 4. Remove the front panel (see the previous section).
 5. Choose the slot for the device being installed (see Figure 3-16).
-

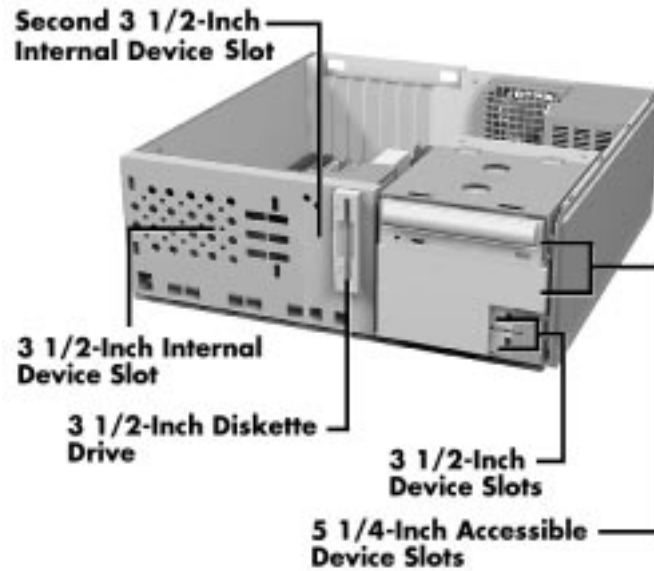

Figure 3-16 Locating Device Slots

- If you are installing the device in the second 3 1/2-inch internal device slot, Remove the two screws securing the 3 1/2-inch hard disk bracket to the front of the system unit.



Figure 3-17 Removing the Bracket Screws

- Slide the 3 1/2-inch hard disk bracket towards the back of the system unit until it is free of the molded plastic.
- Align the two screw holes on the hard disk with the two tabs on the bracket. Slide the hard disk onto the tabs.

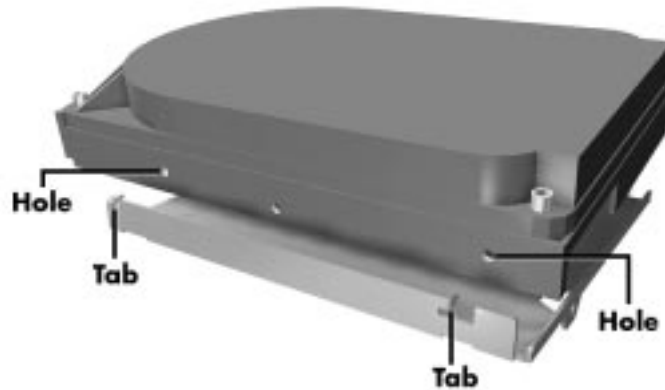

Figure 3-18 *Aligning the Holes and Tabs*

- Place the hard disk into the bracket and secure with the screw.

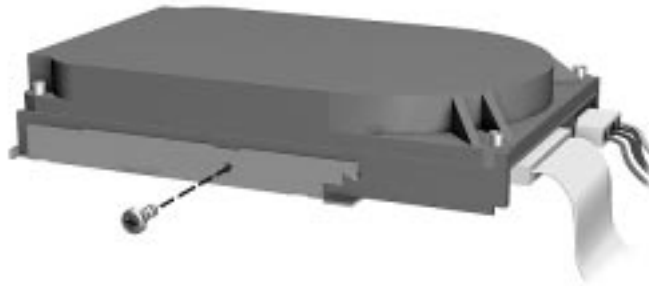

Figure 3-19 *Securing the Disk*

- Slide the bracket into the molded plastic drive slot. Secure the bracket to the front panel with the two screws shown in figure 3-17.
- If you are installing the device in the 3 1/2-inch internal device slot, simply insert the drive into the opening until it is secured (see Figure 3-20). Secure the drive with two screws inserted into the front of the system.

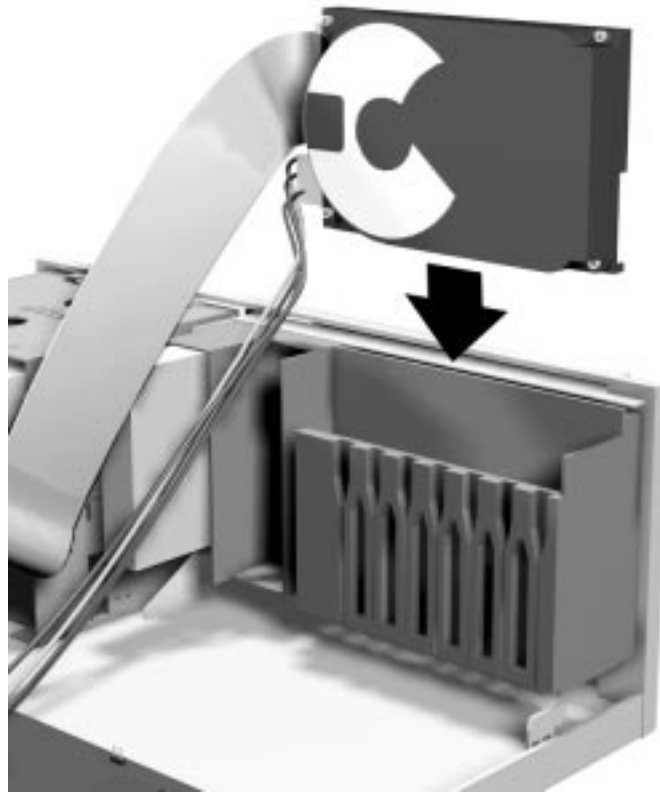

Figure 3-20 *Inserting the Device*

- If you are installing the device in an accessible slot, go to step 6.

6. To install a 3 1/2-inch device in an accessible slot:

- Remove the plastic blank panel from the selected slot by pressing the panel tab inward and swinging the blank panel out (see Figure 3-21).



Figure 3-21 *Removing the Blank Panel*

- Use a screw driver to remove the metal slot cover by carefully pressing it until it breaks away from the chassis. Be careful of sharp edges!
 - Slide the device into the slot and secure the device.
7. Connect the device cables (see “Cabling an IDE Device”).
 8. Replace the front panel.
 9. Replace the access cover.

Installing a 5 1/4-Inch Device

Install an accessible device into the device slot as follows.

1. Follow the preinstallation instructions that came with the device, such as setting jumpers and switches.

NOTE: If your 5 1/4-inch device comes with drive rails, do not attach them. Remove any rails attached. See the documentation that comes with the device.

2. Remove the access cover.
3. Remove the device cage (see “Removing the CD-ROM/DVD Drive”).
4. Remove and label any cables that interfere with installing the device.
5. Remove the front panel.
6. Remove the plastic blank panel. If you are installing a hard drive, keep the panel handy.
7. Use a screw driver to remove the metal slot cover by carefully pressing it until it breaks away from the chassis. Be careful of sharp edges.
8. From the front of the system, slide the device, connector end first, into the device slot.

NOTE: To easily access device connectors for cabling, do not insert a 5 1/4-inch device all the way into the slot.

9. Connect the device cables (see “Cabling Storage Devices”).
 10. Align the holes in the device with the holes in the chassis.
-

11. Secure the device with the screws that came with the device (see Figure 3-22).



Figure 3-22 *Installing the Device*

NOTE: If you removed the accessible device cage, replace it. Secure the device cage with the screw.

12. If you installed a hard drive in the 5 1/4-inch slot, replace the plastic panel.
13. Replace the front panel.
14. Replace the access cover.

Replacing the Front Panel

To replace the front panel, follow this procedure.

1. Align the front panel's six tabs with their corresponding slots on the system (three of the tabs have holes, the others have prongs).
 2. Press the front panel squarely into position until the tabs lock the panel in place.
 3. Replace the access cover.
 4. After securing your system, reboot it and run the Setup program to set the new configuration.
-

ADDING EXTERNAL OPTIONS

External connectors on the back of the system unit allow for a variety of industry-standard options.

This subsection provides the installation procedures for the most commonly used external options, which are as follows:

- parallel printer
- serial devices.

For other external devices, see the instructions that come with the option.

Parallel Printer

NOTE: Before connecting a printer to the system, be sure the printer is set up correctly. Follow the setup instructions that come with the printer.

Connect a parallel printer to the system as follows.

1. Turn off power to the system and printer.
 2. Connect the printer cable to the printer port on the rear of the system unit (see Figure 3-23).
 3. Secure the cable with the screws provided.
 4. Connect the other end to the printer.
-

5. Turn on the printer and the computer.



Figure 3-23 Locating the Parallel Port

RS-232C Device Connection

NOTE: Before connecting a serial device to the system, be sure the serial device is set up correctly. Follow the setup instructions that come with the option.

1. Turn off power to the system and to the serial device.
2. Connect one end of the serial cable to one of the COM ports on the rear of the computer (see Figure 3-24).
3. Secure the cable with the screws provided.
4. Connect the other end to the serial device.
5. Turn on the serial device and the computer.



Figure 3-24 Locating COM1 and COM2

Section 4

Maintenance and Troubleshooting

This section provides information on maintaining and troubleshooting the Direction Series computers. Table 4-1 provides the NEC CSD service telephone numbers. Also included in this section are the error beep code descriptions and a procedure for replacing the CMOS battery.

Table 4-1 NEC CSD Service and Information Telephone Numbers

Service	Telephone Number
To contact the NEC CSD Direction Technical Support Center (TSC):	In the U.S., call 1 (888) 632-2678
To order spare parts:	In the U.S., call 1 (800) 233-6321 In Canada, call 1 (800) 727-2787
To contact Customer Service about service and contract warranty issues:	Call 1 (888) 632-9128
To log onto the NEC CSD Electronic Bulletin Board System (BBS) to download software drivers and the latest BIOS for ROM flashing:	Call 1 (978) 635-4706
For information about NEC CSD products, call FaxFlash SM (use the automated service to have the latest Technical Information Bulletins sent to your fax machine 24 hours a day):	In the U.S., 1 (888) 329-0088 1 (888) FAX-0088 Outside the U.S., call 1 (978) 635-6090
To send technical questions over email:	tech-support@neccsd.com
To fax technical questions to customer support:	In the U.S., fax 1 (978) 635-4666
To access the NEC CSD Website:	www.necnow.com
To access the NEC CSD FTP site:	ftp.nectech.com
To purchase a new system through NEC NOW, or to obtain sales literature:	Call 1 (888) 8NEC-NOW

MAINTENANCE

This subsection contains general information for cleaning and checking the system, keyboard, and monitor.

The system, keyboard, and monitor require cleaning and checking at least once a year, and more often if operating in a dusty environment. No other scheduled maintenance or lubrication is required.

WARNING: Unplug all power cords before performing any maintenance. Voltage is present inside the system and monitor even after the power button is off. All voltage is removed only when the power cord is unplugged.

System Cleaning

Use the following procedure for cleaning the system.

1. Power off the system and unplug all power cables.
2. Periodically wipe the outside of the system, keyboard, mouse, and monitor with a soft, clean cloth. Remove stains with a mild detergent. Do not use solvents or strong, abrasive cleaners on any part of the system.
3. Clean the monitor screen with a commercial monitor screen cleaning kit. Or use a glass cleaner, then wipe with a clean lint-free cloth.
4. Local distributors and dealers may sell diskette drive head cleaning kits. These kits contain special diskettes and cleaning solution. Do not use the abrasive head cleaning kits (kits without cleaning solution).

Insert the diskette immediately after powering on the system, before the disk bootup. Allow the diskette drive heads to clean for about 30 seconds.

Keyboard Cleaning

As necessary, inspect and clean the inside of the keyboard as follows.

1. Remove the eight screws holding the keyboard enclosure together.

NOTE: The keyboard and cable together are considered a whole-unit, field-replaceable assembly. Therefore, disassembly of the keyboard is necessary only when cleaning the inside.

2. Separate the two halves of the enclosure. Clean the enclosure and keys with a damp cloth. A small, soft-bristle brush may be used to clean between the keys. Do not wet or dampen the keyboard's printed circuit board (PCB). If the PCB accidentally gets wet, thoroughly dry it before reattaching the keyboard to the system unit.

Mouse Cleaning

Under normal conditions, the mouse has a self-cleaning mechanism that prevents a buildup of dust or lint around the mouse ball and tracking mechanism. Periodically, however, the mouse ball must be cleaned. Use the following procedure to clean the mouse.

1. Unplug the mouse from the system.
 2. Turn the mouse upside down and locate the mouse ball cover (see Figure 4-1).
-

3. Turn the ball cover clockwise and remove the cover.



Figure 4-1 *Removing the Mouse Ball Cover*

4. Turn the mouse over and remove the ball.
5. Clean the mouse as follows:
 - Clean the mouse ball with tap water and a mild detergent, then dry it with a lint-free cloth.
 - Remove any dust and lint from the mouse socket.
6. Replace the mouse ball in its socket.
7. Replace the ball cover and turn it counterclockwise until it locks in place.

TROUBLESHOOTING

This subsection provides information that helps isolate and repair system malfunctions at the field level. Step-by-step instructions for diagnosing and solving system hardware problems are provided. Technical support is available at 1-888-632-2678.

If disassembly is required, see Section 5. Connector pin assignments are given in Appendix B. Jumper settings are given in the appendices.

Diagnosing and Solving Problems

One beep indicates that the system has completed its power-on self-test (POST) test. If intermittent beeping occurs, power off the system and try again. If the beeping persists, see Table 4-2 and Table 4-3. The following table summarizes problems that may develop during system operation and lists (in sequential order) suggested corrective actions.

Table 4-2 Problems and Solutions

Problem	Symptom	Solution
No power	Power lamp on computer status panel will not light.	<ol style="list-style-type: none"> 1. Check that the power cord is plugged into the AC connector on the computer. Check that the other end of the cord is plugged into a live properly grounded AC power outlet. 2. Check cable connections between the power supply and system board. 3. Systematically eliminate possible shorted PCBs by removing cables and expansion boards. 4. Check the +5 and +12 power supply voltages (see Appendix B, "Connector Pin Assignments"). Measure voltages with the system board installed. 5. Replace the power supply. 6. Replace the system board.
Power supply malfunction	<p>Any of the following conditions could occur:</p> <p>Front panel lamps out, diskette and/or hard drives do not spin, monitor blank, interface ports not working, and keyboard lamp out and/or cannot input from keyboard.</p>	<ol style="list-style-type: none"> 1. Perform steps 1 through 4 listed in this table under No Power. 2. Check power supply voltages. Voltages should be measured with a load on them (system board plugged in). See Appendix B for connector pin assignments. 3. Replace the power supply.

Table 4-2 Problems and Solutions

Problem	Symptom	Solution
Operating system does not boot	Intermittent beeping at power-on. Computer beeps more than once and is unable to complete bootup.	<ol style="list-style-type: none"> 1. Check system configuration (see Section 2). 2. Check all jumper settings and verify that drives are enabled (see appendices and Section 2). 3. Reseat DIMMs and option boards in their connectors. Inspect system board for dropped objects. 4. Remove option boards and reboot. 5. Replace system board.
	“Invalid Configuration” message displayed.	<ol style="list-style-type: none"> 1. Press F2 to run Setup and correct the parameters. 2. Replace the CMOS battery if the date and time must be set each time the computer is powered on.
	Computer halts during loading sequence.	<ol style="list-style-type: none"> 1. Power the computer off. Check for proper jumper settings (see appendices), then power on the computer. 2. Check condition of selected bootload device (diskette or hard disk) for bad boot track or incorrect OS files. 3. Try booting OS from diskette or recopy OS files onto hard disk. 4. Verify correct hard disk is selected.
Diskette drive does not work	Lamp on drive panel does not light when diskette is loaded.	<ol style="list-style-type: none"> 1. Check power and signal cable connections between diskette drive, system board, and power supply. 2. Check diskette drive jumpers. 3. Check diskette cable. Replace as necessary. 4. Check power supply. 5. Replace diskette drive. 6. Replace system board.

Table 4-2 Problems and Solutions

Problem	Symptom	Solution
Hard drive malfunction	Hard drive lamp does not light but hard drive can be accessed.	1. Check cable connections between lamp and system board.
	Hard drive controller failure message displayed.	1. Check that the IDE port and hard drives are enabled in Setup.
	Cannot access hard disk.	1. Check signal/power connections between hard disk, system board, power supply. 2. Check hard drive jumper settings. 3. Check power supply. 4. Check hard disk cable and hard disk. Replace as necessary. 5. Replace system board (or hard disk controller board if the system board controller is not used).
Memory malfunction	Total memory not recognized.	1. Reseat DIMMs. 2. Systematically swap DIMMs. 3. Check to see if the DIMM configuration is valid (see Section 3). 4. Replace DIMMs. 5. Replace system board.
Modem board malfunction	No output from board.	1. Check interrupts (see Appendix C). 2. Check DMA channels (see Section 1).
Keyboard or mouse malfunction	Monitor has prompt, but cannot input data.	1. Check that keyboard/mouse is plugged in. 2. Check password (see Section 2). 3. Disable password (see Appendix C). 4. Replace keyboard (or mouse). 5. Replace system board.

Table 4-2 Problems and Solutions

Problem	Symptom	Solution
Monitor malfunction	Unable to synchronize display.	<ol style="list-style-type: none"> 1. Adjust the monitor's synchronization controls. 2. Check that the monitor's resolution matches the video setting or the video driver used. 3. Check that the utility is not selecting a refresh rate/resolution that is not supported by the monitor. 4. Check that the driver used matches the capabilities of the video controller and memory.
	Wavy display.	<ol style="list-style-type: none"> 1. Check that the computer and monitor are not near motors or electric fields.
	Blank display.	<ol style="list-style-type: none"> 1. Press any key or move the mouse to ensure power management has not blanked the display. 2. Check that the monitor power switch is on. 3. Check that the monitor cable is attached to the video connector at the back of the system. 4. Check cable connections between the AC power supply and monitor. 5. Adjust brightness and contrast controls on the monitor. 6. Check cable connections between the monitor connector and the system board. 7. Replace system board. 8. Replace monitor.

Table 4-2 Problems and Solutions

Problem	Symptom	Solution
CD-ROM/DVD drive malfunction	System power not on.	1. Turn system power on.
	Disc tray does not open.	1. System power not on. Turn system power on. 2. System power failed. Insert about an inch of a straightened paper clip into the emergency eject hole, until the tray opens.
	Cannot access CD-ROM/DVD drive.	1. Check that the driver software is loaded and not corrupted. 2. Check signal and power connections between the drive, system board, and power supply. 3. Check the master/slave jumper settings. 4. Check the IDE cable. Replace as necessary. 5. Check the power supply. Replace as necessary. 6. Check the system board. Replace as necessary.
	No sound from CDs.	1. Check that speaker power is on and volume is adjusted. 2. Check audio software settings. 3. Check the CD disc. 4. Check the audio cable. Replace as necessary. 5. Replace the CD-ROM/DVD drive. 6. Replace the system board.
Zip drive malfunction	System power not on	1. Turn system power on.
	Cannot access Zip drive.	1. Check that the Zip drive driver software is loaded and not corrupted. 2. Check signal and power connections between the Zip drive, system board, and power supply. 3. Check the master/slave jumper settings.

Table 4-2 Problems and Solutions

Problem	Symptom	Solution
Communication error	No or bad data when communicating.	<ol style="list-style-type: none">4. Check the IDE cable. Replace as necessary.5. Check the power supply. Replace as necessary.6. Check the system board. Replace as necessary. <ol style="list-style-type: none">1. Check cable connections between system board and device.2. Check that the interface port is selected.3. Test or replace the device and interface cable (see the device documentation for troubleshooting).4. Replace the system board.

Beep Codes

During boot up, the computer performs a series of POST (Power On Self Test) routines. A beep code may appear when an error is detected. There are fatal and nonfatal errors. The fatal errors include BIOS, CMOS, DMA, RAM, video, and keyboard controller errors. The nonfatal errors include timer tick interrupt, shutdown test, unexpected interrupt in protected mode, gate A20, RAM test, interval timer channel 2 test, clock, serial and parallel port test, math co-processor, system board select, and extended CMOS RAM.

The following table provides a description of the beep codes.

Table 4-3 Beep Code Descriptions

Beeps	Description
1	One short beep before boot
1-2	Search for option ROMs
1-2-2-3	BIOS ROM checksum
1-3-1-1	Test DRAM refresh
1-3-1-3	Test 8742 keyboard controller
1-3-4-1	RAM failure on address line xxxx
1-3-4-3	RAM failure on data bits xxxx of low byte of memory bus
1-4-1-1	RAM failure on data bits xxxx of high byte of memory bus
2-1-2-3	Check ROM copyright notice
2-2-3-1	Test for unexpected interrupts

CMOS Battery Replacement

Remove the 3-volt lithium battery from the system board as follows.

1. Turn off and unplug the system unit and any external options connected to the system.

CAUTION: Removing the battery from the system board causes the computer to lose system configuration information. If possible, run Setup and record the system configuration settings before removing the battery. Use that information to restore the system after replacing the battery.

2. Remove the system access cover.

3. Locate the battery and its socket on the system board (see Figure 4-2).

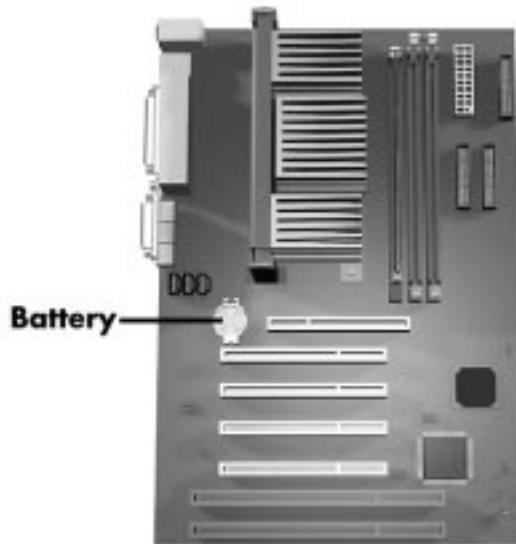

Figure 4-2 *Locating the Battery*

4. Use fingers to carefully pull the battery up until it is clear to slide the battery out of the socket.

WARNING: The battery can explode if it is incorrectly replaced or improperly discarded. Use only the same battery or an equivalent type recommended by the manufacturer when replacing the battery.

Lithium acts as a catalyst when exposed to water and causes spontaneous combustion on contact. Discard used batteries according to the manufacturer's instructions.

5. With the positive (+) side facing up, press the new battery into the socket.
 6. Replace the system access cover.
 7. Connect external peripherals and power cables.
 8. Run Setup to reconfigure system parameters (see Section 2).
-

Section 5

Disassembly and Reassembly

This section contains step-by-step disassembly procedures for the system unit. Reassembly is the reverse of disassembly. The procedures are supported by simplified disassembly illustrations to facilitate removal.

A Phillips-head screwdriver is the only required tool. For complete disassembly of the system unit, follow the disassembly order listed in table 5-1. To reassemble, follow the table and procedures in reverse order.

Individual removal procedures do not require the total disassembly of the computer. Each of the following subsections lists the parts that must be removed before beginning the removal procedure.

Table 5-1 Disassembly Sequence

Sequence	Part	See Page
1	System access cover	5-2
2	Expansion board(s)	5-2
3	Front panel	5-3
4	Side panel	5-4
5	Device cage	5-4
6	Diskette drive	5-4
7	5 1/4-inch device	5-5
8	Optional 3 1/2-inch hard disk drive	5-6
9	Standard 3 1/2-inch hard disk drive	5-8
10	Fan assembly	5-8
11	DIMM module	5-9
12	Power supply	5-10
13	System board	5-11

When disassembling the system unit, follow these general rules.

- Disconnect all peripherals.
- When handling boards or chips, touch the system unit frame to discharge static.
- Do not disassemble parts other than those specified in the procedure.
- Use a Phillips-head screw driver, unless otherwise specified.
- Label all removed connectors. Note where the connector goes and in what position it was installed.

On completion of any reassembly, perform a power-on self-test (see Section 4, “Maintenance and Troubleshooting”). If a fault occurs, verify that the reassembly was performed correctly.

CAUTION: When handling boards or chips, ground yourself to release static.

DISASSEMBLY

Use the following procedures to disassemble the system unit.

NOTE: Unplug the power cord before disassembling the system unit. Voltage is present inside the system unit even after the power is off. All voltage is removed only when the power cord is unplugged.

System Access Cover

To remove and replace the system access cover, see Section 3.

Expansion Board Removal

Remove any installed expansion board(s) per the following steps.

1. Remove the system access cover as described in Section 3.
 2. Disconnect any cables leading from the expansion board(s).
 3. Remove the screw that secures the board to the support bracket.
 4. Pull the board out of the connector. Gently rock the board from side-to-side to release it from its connector (see Figure 5-1).
-

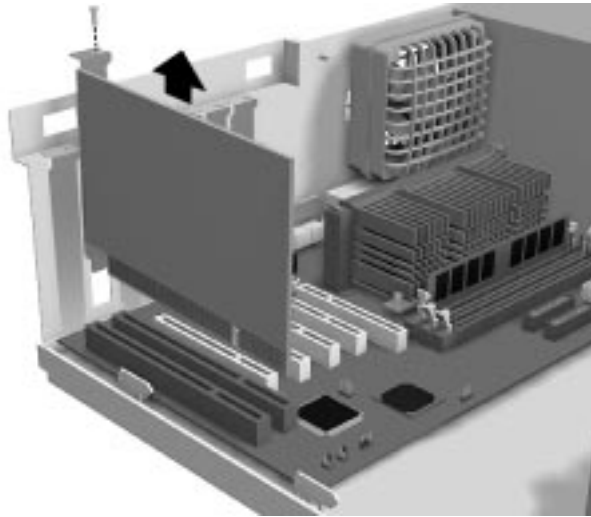

Figure 5-1 *Removing a Board*

Front Panel Removal

Remove the front panel from the system unit as follows.

1. Locate the two plastic tabs at the front of the chassis. They are indicated by two arrows engraved on the chassis.
2. Press down on the two tabs and press in a third tab at the end of the panel to release the panel (see Figure 5-2).

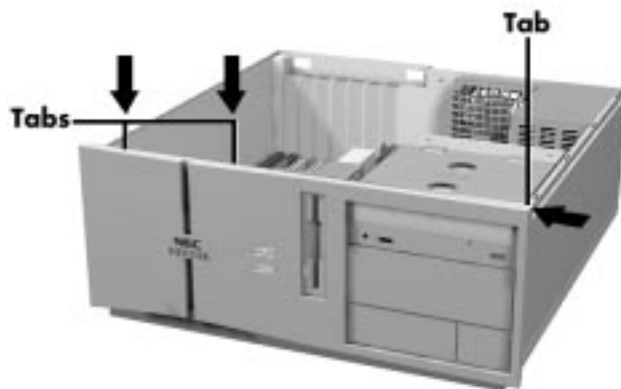

Figure 5-2 *Releasing the Front Panel*

3. Pull the panel away from the chassis.
-

Side Panel Removal

Remove the side panel from the system unit as follows.

1. Remove the system access cover and front panel as previously described.
2. Locate the two side panel securing tabs at the front of the system.
3. Pull the tabs out and away from the system.
4. Slide the side panel towards the rear of the unit and away from the unit.

Device Cage Removal

Remove the device cage from the system unit as follows.

1. Label and disconnect any cables connected to devices in the device cage.
2. Locate the screw on the front of the system between the 3.5-inch blank panel and diskette drive (see Figure 5-3). Remove the screw.

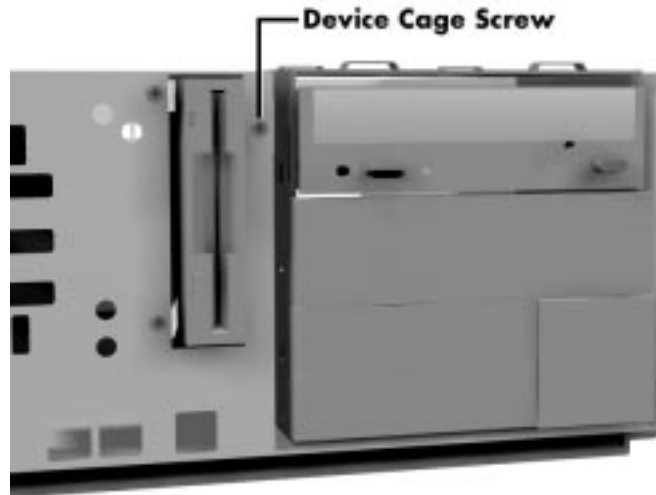

Figure 5-3 *Locating the Device Cage Screw*

3. Slide the cage towards the front of the system and lift it out of the unit.

Diskette Drive Removal

Remove the standard diskette drive from the system unit as follows.

1. Remove the system access cover and front panel as previously described.
 2. Label and unplug the signal and power cables for the diskette drive.
-

3. Locate the two clips at the front of the system that secure the diskette drive.

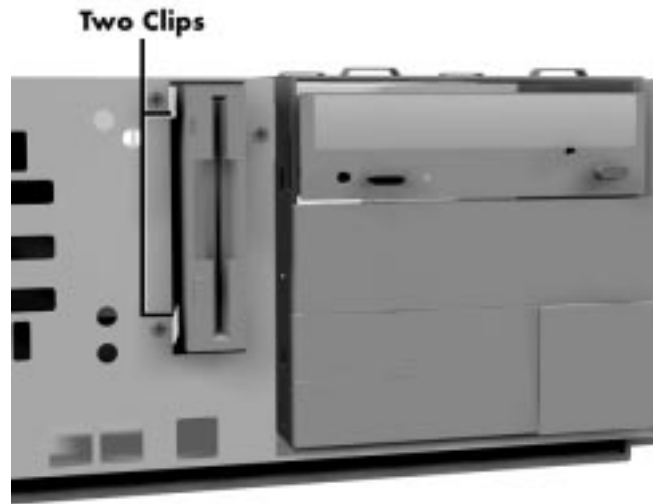

Figure 5-4 Locating the Two Diskette Drive Clips

4. Squeeze the two clips and pull the diskette drive out of the front of the system.

5 1/4-Inch Device Removal

Remove an optional 5 1/4-inch device from the system unit as follows.

1. Remove the system access cover, front panel, and the device cage as previously described.
 2. Label and unplug the signal and power cables from the optional device in the 5 1/4-inch device cage. Unplug the audio cable from an optional CD ROM drive.
-

3. Remove the screws holding the device in the cage (see Figure 5-5).



Figure 5-5 *Removing the 5 1/4-Inch Device Screws*

4. Slide the device out from the front of the system unit.

Optional 3 1/2-Inch Hard Disk Drive Removal

Remove the optional 3 1/2-inch hard disk drive as follows.

1. Remove the system access cover and front panel as previously described.
2. Label and unplug the hard disk drive power and signal cables from the hard disk drive.
3. Remove the two screws securing the 3 1/2-inch hard disk drive brackets to the front of the system unit (see Figure 5-6).

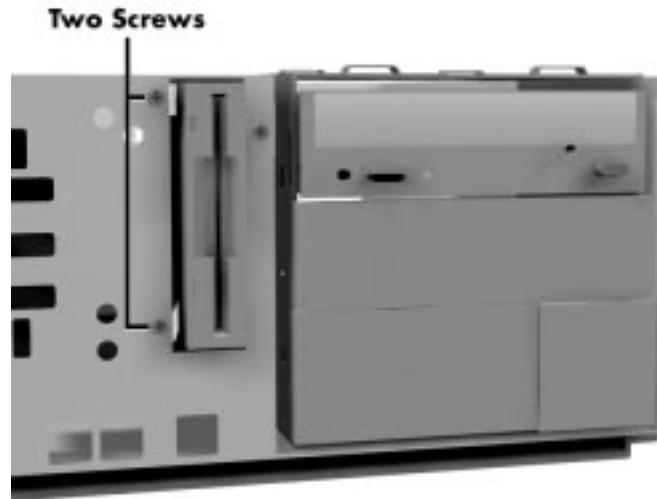

Figure 5-6 *The 3 1/2-Inch Device Bracket Screws*

4. Slide the 3 1/2-inch hard disk drive towards the back of the system unit until it is free of the molded plastic.
5. Remove the screw on the side of the hard disk securing it to the bracket.

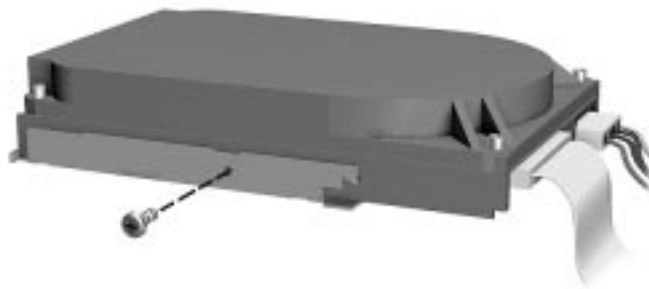

Figure 5-7 *Removing the Securing Screw*

6. Slowly pull the hard disk away from the bracket and lift the disk out of the two securing tabs on the opposite side of the bracket.

Standard 3 1/2-Inch Hard Disk Drive Removal

Remove the standard 3 1/2-inch hard disk drive as follows.

1. Remove the system access cover and front panel as previously described.
2. Unplug the hard disk drive power and signal cables from the optional hard disk drive.
3. Locate the two screws securing the 3 1/2-inch hard disk drive in the molded plastic cage at the front of the system. Remove the screws.
4. Release the two plastic clips inside the plastic cage holding the drive in the plastic cage and slide the drive up and out of the cage.

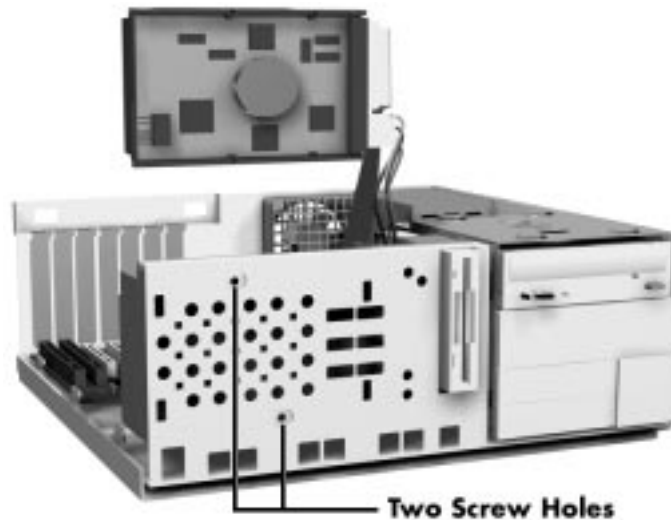

Figure 5-8 Removing the Drive

Fan Assembly Removal

Remove the fan assembly per the following steps.

1. Remove the system access cover per Section 3.
 2. At the rear of the system unit, press in on the two locking tabs securing the assembly to the chassis.
 3. Remove the fan by pulling it outward away from the system board.
-

DIMM Module Removal

Remove any optional DIMM modules from the system board as follows.

1. Remove the system access cover and any expansion boards as previously described.
2. Press the locking clips at the ends of the socket away from the DIMM memory module (see Figure 5-9).
3. Gently rock the module while pulling it up from the socket.

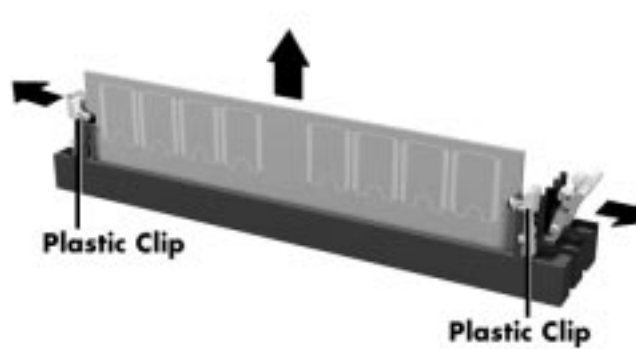

Figure 5-9 *Removing a DIMM*

When installing a DIMM module, align the notches on the module with the keys in the memory socket, insert the module, and press in the plastic locking clips.

Power Supply Removal

Remove the power supply as follows.

1. Remove the system access cover as previously described.
2. Label and unplug the power cable attached to the system board.
3. Label and unplug the power cables from all installed devices.
4. At the back of the system unit, remove the two screws securing the power supply to the system unit (see Figure 5-10).



Figure 5-10 Removing the Power Supply Screws

5. Pull the power supply out of the system unit.
-

System Board Removal

Remove the system board per the following steps.

1. Remove the system access cover, expansion boards, fan assembly, and power supply as previously described.
2. Remove and label all cables connected to the system board. Appendix B provides the connector identifiers and pin assignments for each connector.
3. Locate and remove the one screw at the rear of the unit that secures the system board to the system unit (see Figure 5-11).



Figure 5-11 Removing the System Board Screw

4. Slide the system board towards the front of the unit until it is clear of the metal shielding and the alignment clips.
5. Lift the board out of the system at an angle.
6. If replacing the system board, remove any installed DIMMs from the board. Reinstall the DIMMs on the new board.

ILLUSTRATED PARTS BREAKDOWN

This section contains the illustrated parts breakdown (IPB) and NEC CSD part numbers for the Direction L Series, SPL Series, and SP Series desktop and minitower computers.

Table 5-2 lists the field-replaceable parts for the L Series desktop and Figure 5-12 provides the illustrated parts breakdown. Table 5-3 lists the field-replaceable parts for the L Series minitower and Figure 5-13 provides the illustrated parts breakdown.

Table 5-4 lists the field-replaceable parts for the SPL Series and SP Series desktop and Figure 5-14 provides the illustrated parts breakdown. Table 5-5 lists the field replaceable parts for the SPL Series and SP Series minitower and Figure 5-15 provides the illustrated parts breakdown.

Table 5-2 Direction L Series Desktop Field-Replaceable Parts List*

Item	Description	Part Number
1	Keyboard, Ergo	229-00012
2a	24x CD-ROM drive	730302-02
2b	32x CD-ROM drive (on some models)	730330
3a	Ditto 3200 tape drive, backup	320547
3b	Seagate tape drive, CTT8001-S	320545
3c	SCSI tape backup unit, Seagate CTD8000R-S	320705
4	Iomega ATAPI Zip drive	320703
5	Zip cartridge	142418
6a	3.2-GB IDE hard disk, Quantum ST Ultra DMA	300668-01
6b	4.3-GB IDE hard disk, Quantum ST Ultra DMA	215-00125
6c	7-GB IDE hard disk, Maxtor	300800
6d	6.4-GB hard disk, IBM Ultra DMA	300815
6e	8.4-GB IDE hard disk, Maxtor 88400D8, UDMA	300819-01
6f	9.1-GB UDMA hard disk	300833
6g	3.5"x1.6" 9.1-GB, Seagate Ultra wide SCSI, ST19171W	300689
6h	3.5"x1.6" 9.1-GB, Seagate Ultra wide SCSI, ST19101	300690
6i	3.5"x1" 4.35-GB, Seagate Ultra wide SCSI, ST34371W	300652
6j	3.5"x1" 4.5-GB, Seagate Ultra wide SCSI, ST34501W	300691
7	3.5-inch diskette drive	219-00012
8	Microphone	232-00011
9	Speaker	158-056684-000
10	Left side cover	158-056682-000
11	Top cover (access cover)	158-056680-000
12	Front panel (need to order logo plate separately)	158-056678-000

* This data was prepared June 1998. For an up-to-date listing of spare parts, please call FaxFlashSM at 1-888-329-0088 (or 1-978-635-6090 outside the U.S.) and order document 42102018.

Table 5-2 Direction L Series Desktop Field-Replaceable Parts List*

Item	Description	Part Number
13	Right side cover	158-056681-000
14	Power supply - Sparkle	190300
15a	Altec Lansing speakers, ACS90	160312
15b	Altec Lansing speakers, ACS45	160314
15c	Altec Lansing speakers, ACS410	160313
15d	Altec Lansing subwoofer, ACS251 (for ACS410)	160315
16	Fan assembly	158-056683-000
17a	Video board, #9 Revolution 3D, AGP	060201
17b	Video board, #9 Reality 334, AGP	060215
17c	Video board, Diamond Viper V330, AGP	060214
18a	U.S. Robotics Winmodem	090304
18b	U.S. Robotics modem board	090134
19a	3C509B network board	158-050796-000
19b	3COM PCI 10/100 3C905TX ethernet board	158-052256-000A
20a	2940 Adaptec UW SCSI adapter board	158-052132-000A
20b	2930 Adaptec SCSI adapter board	030295
20c	Intel pro 100 network adapter board	145479
21	Diskette drive signal cable	070114
22	IDE signal cable	233-00026
23	Cable, audio internal, dual MPC	070808
24	SCSI cable	233-00027
25	Microsoft Mouse	230-00025
26	Retention mechanism kit	301-00038
27a	233-MHz Pentium II with active heatsink	158-056692-000
27b	266-MHz Pentium II with active heatsink	158-056693-000
27c	300-MHz Pentium II with active heatsink	158-056694-000
27d	333-MHz Pentium II with active heatsink	158-056729-000
	Active heatsink (not shown in figure)	149786
28	System board	158-056690-000
29a	16-MB DIMM - non-parity	081780
29b	32-MB DIMM - non-parity	081779
29c	64-MB DIMM - non-parity	081794

Table 5-2 Direction L Series Desktop Field-Replaceable Parts List*

Item	Description	Part Number
30	AC power cable	070135
31	4-MB memory upgrade (for #9 Revolution 3D)	060204
32	I/O shield	149763
	Cable, VMI — DVD PCI board to V330 video board (not shown in figure)	070805
	Cable, diskette drive, 655 mm, 3 connector (not shown in figure)	233-00013
	Power strip, surge protector (not shown in figure)	213-00009
	System power switch (not shown in figure)	130047
	Phone cable, modem (not shown in figure)	158-050519-001
	Card, sound wavetable OPL4 (not shown in figure)	030401
	SCSI cable, wide (not shown in figure)	233-00045
	CD, Restore Pkg., Windows 95 systems only (not shown in figure)	165326-08
	Battery (not shown in figure)	158-060367-000
	Monitor, NEC 15", C550 (not shown in figure)	011001
	Monitor, NEC 17", C700 (not shown in figure)	011002
	Cable, CD-ROM, audio (not shown in figure)	070112
	Microsoft SideWinder 3D joystick (not shown in figure)	160409
	DirecPC PCI board (not shown in figure)	149834
	DVD drive, Hitachi (not shown in figure)	730124
	DVD PCI board, Quadrant (not shown in figure)	060212
	Parallel printer cable (not shown in figure)	070829
	233L logo plate (not shown in figure)	144760
	266L logo plate (not shown in figure)	144761
	300L logo plate (not shown in figure)	144759
	333L logo plate (not shown in figure)	144771

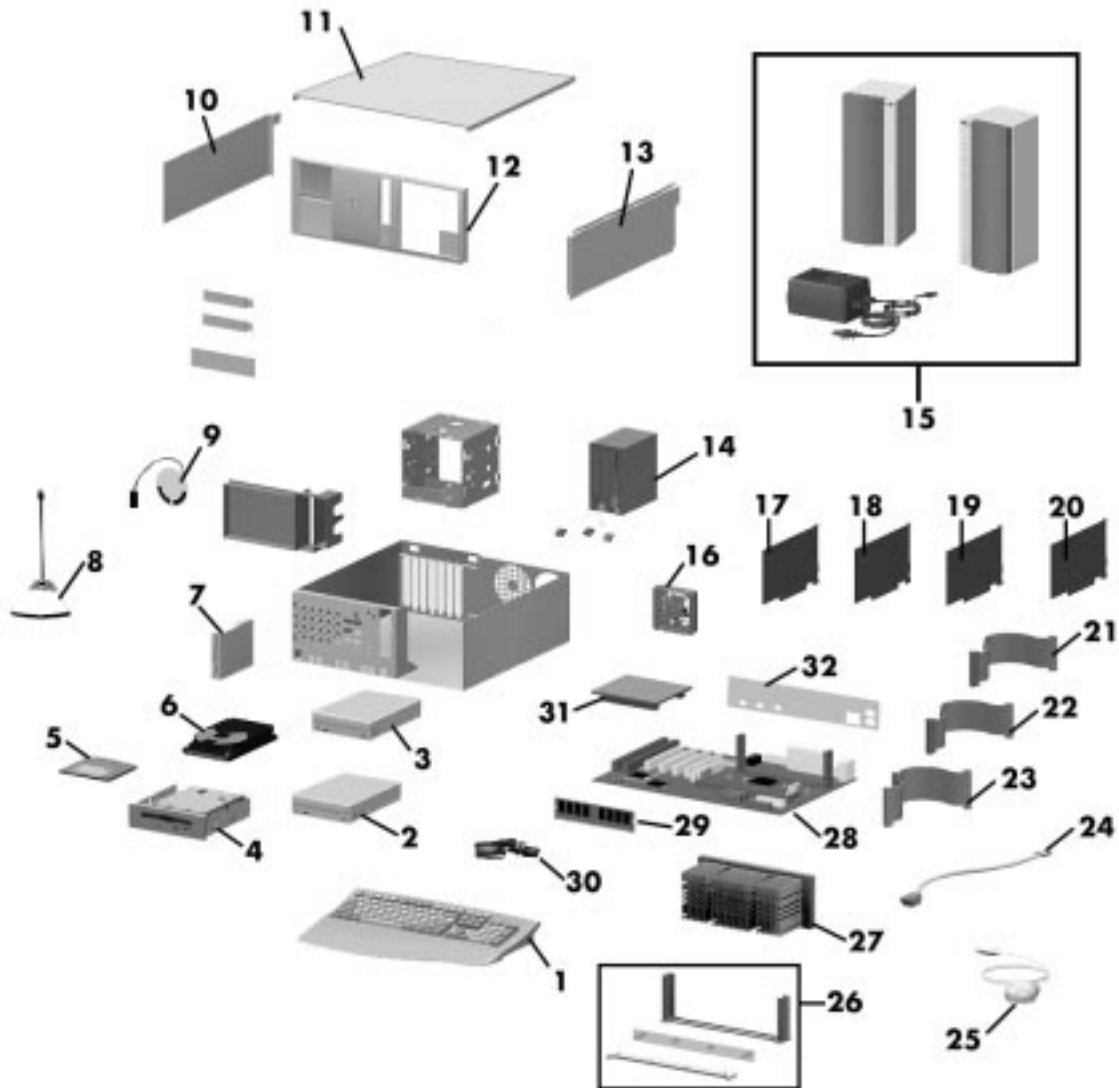

Figure 5-12 *Direction L Series Desktop Illustrated Parts Breakdown**

* This data was prepared June 1998. For an up-to-date listing of spare parts, please call FaxFlashSM at 1-888-329-0088 (or 1-978-635-6090 outside the U.S.) and order document 42102018.

Table 5-3 Direction L Series Minitower Field-Replaceable Parts List*

Item	Description	Part Number
1	AC power cable	070135
2	Microphone	232-00011
3	Microsoft Mouse	230-00025
4	Keyboard, Egro	229-00012
5	Cable, audio internal, dual MPC	070808
6	Diskette drive signal cable	070114
7	IDE signal cable	233-00026
8	SCSI cable	233-00027
9	4-MB memory upgrade (for #9 Revolution 3D)	060204
10a	Video board, #9 Revolution 3D, AGP	060201
10b	Video board, #9 Reality 334, AGP	060215
10c	Video board, Diamond Viper V330, AGP	060214
11a	U.S. Robotics Winmodem	090304
11b	U.S. Robotics modem board	090134
12a	3C509B network board	158-050796-000
12b	3COM PCI 10/100 3C905TX ethernet board	158-052256-000A
13a	2940 Adaptec UW SCSI adapter board	158-052132-000A
13b	2930 Adaptec SCSI adapter board	030295
13c	Intel Pro 100 network adapter board	145479
14	System board	158-056690-000
15	I/O shield	149763
16a	233-MHz Pentium II with active heatsink	158-056692-000
16b	266-MHz Pentium II with active heatsink	158-056693-000
16c	300-MHz Pentium II with active heatsink	158-056694-000
16d	333-MHz Pentium II with active heatsink	158-056729-000
	Active heatsink (not shown in figure)	149786
17	Retention mechanism kit	301-00038
18a	16-MB DIMM - non-parity	081780
18b	32-MB DIMM - non-parity	081779
18c	64-MB DIMM - non-parity	081794

* This data was prepared June 1998. For an up-to-date listing of spare parts, please call FaxFlashSM at 1-888-329-0088 (or 1-978-635-6090 outside the U.S.) and order document 42102018.

Table 5-3 Direction L Series Minitower Field-Replaceable Parts List*

Item	Description	Part Number
19	Power supply -Sparkle	190300
20	Fan assembly	158-056683-000
21a	Altec Lansing speakers, ACS90	160312
21b	Altec Lansing speakers, ACS45	160314
21c	Altec Lansing speakers, ACS410	160313
21d	Altec Lansing subwoofer, ACS251 (for ACS410)	160315
22	Left side cover (access cover)	158-056686-000
23	Top cover	158-056685-000
23	Right side cover	158-056687-000
25	Front panel (need to order logo plate separately)	158-056679-000
26	Speaker	158-056684-000
27a	3.2-GB IDE hard disk, Quantum ST Ultra DMA	300668-01
27b	4.3-GB IDE hard disk, Quantum ST Ultra DMA	215-00125
27c	7-GB IDE hard disk, Maxtor	300800
27d	6.4-GB hard disk, IBM Ultra DMA	300815
27e	8.4-GB IDE hard disk, Maxtor 88400D8, UDMA	300819-01
27f	9.1-GB hard disk, UDMA	300833
27g	3.5"x1.6" 9.1-GB, Seagate Ultra wide SCSI, ST19171W	300689
27h	3.5"x1.6" 9.1-GB, Seagate Ultra wide SCSI, ST19101W	300690
27i	3.5"x1" 4.35-GB, Seagate Ultra wide SCSI, ST34371W	300652
27j	3.5"x1" 4.5-GB, Seagate Ultra wide SCSI, ST34501W	300691
28a	24x CD-ROM drive	730302-02
28b	32x CD-ROM drive (on some models)	730330
29	Zip cartridge	142418
30	Iomega ATAPI Zip drive	320703
31	3.5-inch diskette drive	219-00012
32a	Ditto 3200 tape drive, backup	320547
32b	Seagate tape drive, CTT800I-S	320545
32c	SCSI tape backup unit, Seagate CTD8000R-S	320705

Table 5-3 Direction L Series Minitower Field-Replaceable Parts List*

Item	Description	Part Number
	Cable, VMI — DVD PCI board to V330 video board (not shown in figure)	070805
	Cable, diskette drive, 655 mm, 3 connector (not shown in figure)	233-00013
	Power strip, surge protector (not shown in figure)	213-00009
	System power switch (not shown in figure)	130047
	Phone cable, modem (not shown in figure)	158-050519-001
	Monitor, NEC 15", C550 (not shown in figure)	011001
	Monitor, NEC 17", C700 (not shown in figure)	011002
	Card, sound wavetable OPL4 (not shown in figure)	030401
	SCSI cable, wide (not shown in figure)	233-00045
	Cable, CD-ROM, audio (not shown in figure)	070112
	Microsoft SideWinder 3D joystick (not shown in figure)	160409
	CD, Restore Pkg., Windows 95 systems only (not shown in figure)	165326-08
	Battery (not shown in figure)	158-060367-000
	DVD drive, Hitachi (not shown in figure)	730124
	DVD PCI board, Quadrant (not shown in figure)	060212
	DirecPC PCI board (not shown in figure)	149834
	Parallel printer cable (not shown in figure)	070829
	233L logo plate (not shown in figure)	144760
	266L logo plate (not shown in figure)	144761
	300L logo plate (not shown in figure)	144759
	333L logo plate (not shown in figure)	144771

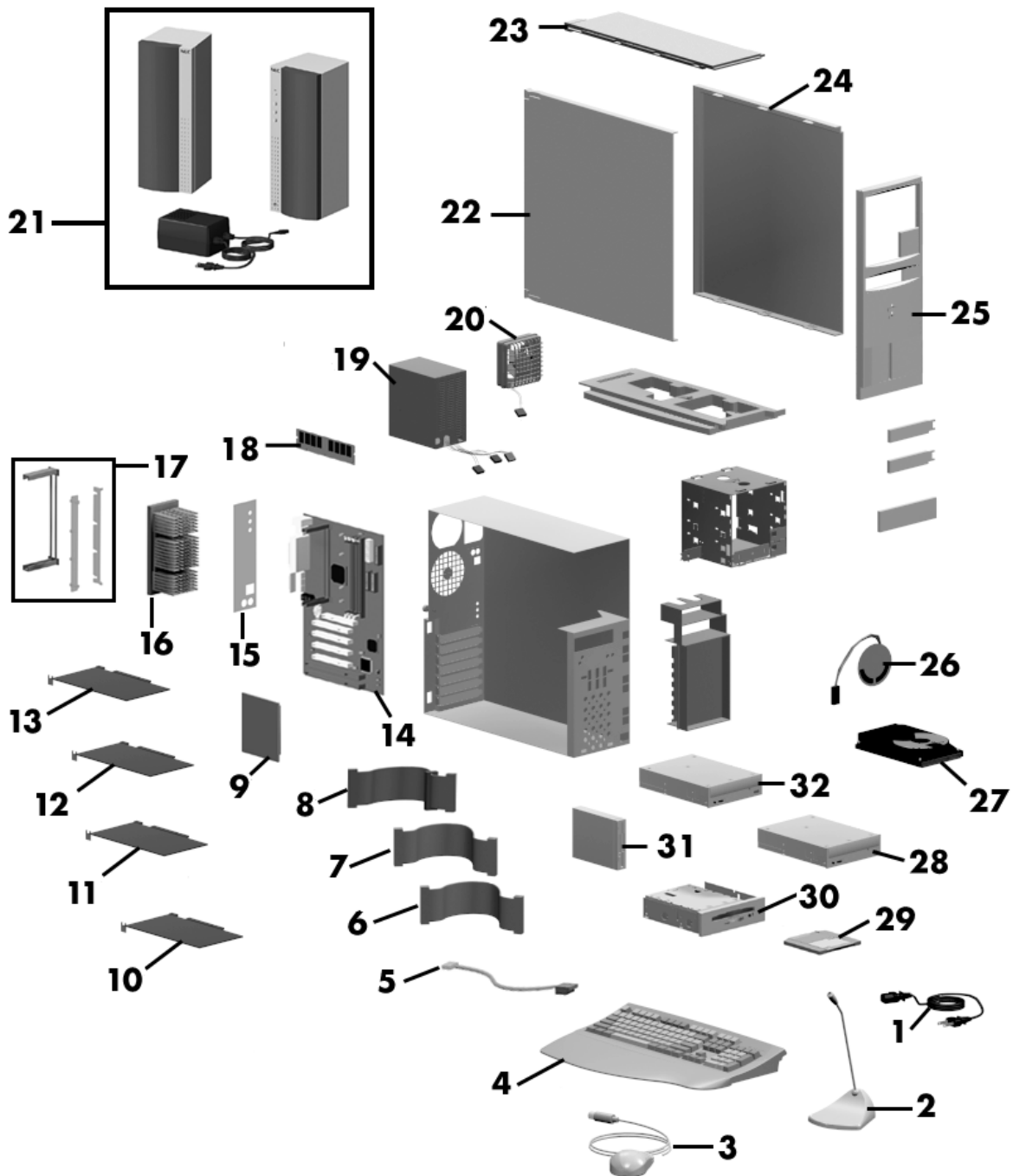

Figure 5-13 Direction L Series Minitower Illustrated Parts Breakdown*

* This data was prepared June 1998. For an up-to-date listing of spare parts, please call FaxFlashSM at 1-888-329-0088 (or 1-978-635-6090 outside the U.S.) and order document 42102018.

Table 5-4 Direction SPL and SP Series Desktop Field-Replaceable Parts List*

Item	Description	Part Number
1	Keyboard, Ergonomic	229-00012
2a	24x CD-ROM drive	730302-02
2b	32x CD-ROM drive (certain models)	730330
3a	Ditto 3200 tape drive, backup	320547
3b	Seagate tape drive, CTT800I-S	320545
3c	SCSI tape backup unit, Seagate CTD8000R-S	320705
4	Iomega ATAPI Zip drive	320703
5	Zip cartridge	142418
6a	3.2-GB IDE hard disk, Quantum ST Ultra DMA	300668-01
6b	4.3-GB IDE hard disk, Quantum ST Ultra DMA	215-00125
6c	7-GB IDE hard disk, Maxtor	300800
6d	6.4-GB hard disk, IBM Ultra DMA	300815
6e	8.4-GB IDE hard disk, Maxtor 88400D8, UDMA	300819-01
6f	9.1-GB hard disk, UDMA	300833
6g	3.5"x1.6" 9.1-GB, Seagate Ultra wide SCSI, ST19171W	300689
6h	3.5"x1.6" 9.1-GB, Seagate Ultra wide SCSI, ST19101	300690
6i	3.5"x1" 4.35-GB, Seagate Ultra wide SCSI, ST34371W	300652
6j	3.5"x1" 4.5-GB, Seagate Ultra wide SCSI, ST34501W	300691
7	3.5-inch diskette drive	219-00012
8	Microphone	232-00011
9	Speaker	158-056684-000
10	Left side cover	158-056682-000
11	Top cover (access cover)	158-056680-000
12	Front panel (need to order logo plate separately)	158-056678-000
13	Right side cover	158-056681-000
14	Power supply - Sparkle	190300
15a	Altec Lansing speakers, ACS90	160312

* This data was prepared June 1998. For an up-to-date listing of spare parts, please call FaxFlashSM at 1-888-329-0088 (or 1-978-635-6090 outside the U.S.) and order document 42102018.

Table 5-4 Direction SPL and SP Series Desktop Field-Replaceable Parts List*

Item	Description	Part Number
15b	Altec Lansing speakers, ACS45	160314
15c	Altec Lansing speakers, ACS410	160313
15d	Altec Lansing subwoofer, ACS251 (for ACS410)	160315
16	Fan assembly	158-056683-000
17a	Video board, #9 Revolution 3D, AGP	060201
17b	Video board, #9 Reality 334, AGP	060215
17c	Video board, Diamond Viper V330, AGP	060214
18	U.S. Robotics modem board	090134
19a	3C509B network board	158-050796-000
19b	3COM PCI 10/100 3C905TX ethernet board	158-052256-000A
20a	2940 Adaptec UW SCSI adapter board	158-052132-000A
20b	2930 Adaptec SCSI adapter board	030295
20c	Intel pro 100 network adapter board	145479
21	Diskette drive signal cable	070114
22	IDE signal cable	233-00026
23	Cable, audio internal, dual MPC	070808
24	SCSI cable	233-00027
25	Microsoft Mouse	230-00025
26	Retention mechanism kit	301-00038
27a	233-MHz Pentium II with active heatsink	158-056692-000
27b	266-MHz Pentium II with active heatsink	158-056693-000
27c	300-MHz Pentium II with active heatsink	158-056694-000
27d	333-MHz Pentium II with active heatsink	158-056729-000
	Active heatsink (not shown in figure)	149786
28	System board	158-056690-000
29a	16-MB DIMM - non-parity	081780
29b	32-MB DIMM - non-parity	081779
29c	64-MB DIMM - non-parity	081794
30	AC power cable	070135
31	4-MB memory upgrade (for #9 Revolution 3D)	060204
32	I/O shield	149763

Table 5-4 Direction SPL and SP Series Desktop Field-Replaceable Parts List*

Item	Description	Part Number
	Cable, VMI — DVD PCI board to V330 video board (not shown in figure)	070805
	Cable, diskette drive, 655 mm, 3 connector (not shown in figure)	233-00013
	Power strip, surge protector (not shown in figure)	213-00009
	System power switch (not shown in figure)	130047
	Phone cable, modem (not shown in figure)	158-050519-001
	Card, sound wavetable OPL4 (not shown in figure)	030401
	SCSI cable, wide (not shown in figure)	233-00045
	CD, Restore Pkg., Windows 95 systems only (not shown in figure)	165326-08
	Battery (not shown in figure)	158-060367-000
	Monitor, NEC 15", C550 (not shown in figure)	011001
	Monitor, NEC 17", C700 (not shown in figure)	011002
	Cable, CD-ROM, audio (not shown in figure)	070112
	Microsoft SideWinder 3D joystick (not shown in figure)	160409
	DirecPC PCI board (not shown in figure)	149834
	DVD drive, Hitachi (not shown in figure)	730124
	DVD PCI board, Quadrant (not shown in figure)	060212
	Parallel printer cable (not shown in figure)	070829
	SPL233 logo plate (not shown in figure)	144724
	SPL266 logo plate (not shown in figure)	144722
	SPL300 logo plate (not shown in figure)	144725
	SPL333 logo plate (not shown in figure)	144758

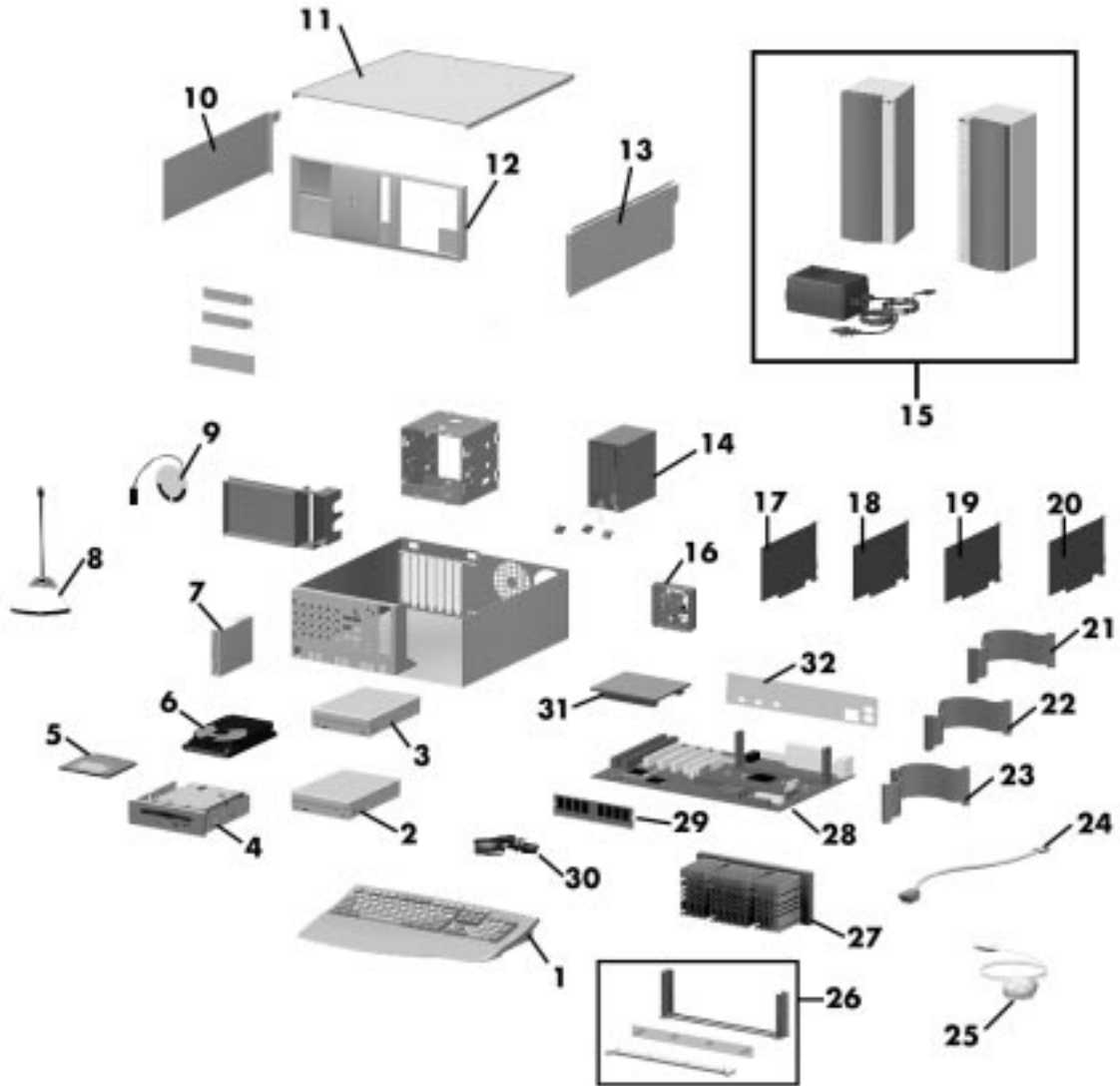

Figure 5-14 *Direction SPL and SP Series Desktop Illustrated Parts Breakdown**

* This data was prepared June 1998. For an up-to-date listing of spare parts, please call FaxFlashSM at 1-888-329-0088 (or 1-978-635-6090 outside the U.S.) and order document 42102018.

Table 5-5 Direction SPL and SP Series Minitower Field-Replaceable Parts List*

Item	Description	Part Number
1	AC power cable	070135
2	Microphone	232-00011
3	Microsoft Mouse	230-00025
4	Keyboard, Ergonomic	229-00012
5	Cable, audio internal, dual MPC	070808
6	Diskette drive signal cable	070114
7	IDE signal cable	233-00026
8	SCSI cable	233-00027
9	4-MB memory upgrade (for #9 Revolution 3D)	060204
10a	Video board, #9 Revolution 3D, AGP	060201
10b	Video board, #9 Reality 334, AGP	060215
10c	Video board, Diamond Viper V330, AGP	060214
11	U.S. Robotics modem board	090134
12a	3C509B network board	158-050796-000
12b	3COM PCI 10/100 3C905TX ethernet board	158-052256-000A
13a	2940 Adaptec UW SCSI adapter board	158-052132-000A
13b	2930 Adaptec SCSI adapter board	030295
13c	Intel Pro 100 network adapter board	145479
14	System board	158-056690-000
15	I/O shield	149763
16a	233-MHz Pentium II with active heatsink	158-056692-000
16b	266-MHz Pentium II with active heatsink	158-056693-000
16c	300-MHz Pentium II with active heatsink	158-056694-000
16d	333-MHz Pentium II with active heatsink	158-056729-000
	Active heatsink (not shown in figure)	149786
17	Retention mechanism kit	301-00038
18a	16-MB DIMM - non-parity	081780
18b	32-MB DIMM - non-parity	081779
18c	64-MB DIMM - non-parity	081794
19	Power supply -Sparkle	190300

* This data was prepared June 1998. For an up-to-date listing of spare parts, please call FaxFlashSM at 1-888-329-0088 (or 1-978-635-6090 outside the U.S.) and order document 42102018.

Table 5-5 Direction SPL and SP Series Minitower Field-Replaceable Parts List*

Item	Description	Part Number
20	Fan assembly	158-056683-000
21a	Altec Lansing speakers, ACS90	160312
21b	Altec Lansing speakers, ACS45	160314
21c	Altec Lansing speakers, ACS410	160313
21d	Altec Lansing subwoofer, ACS251 (for ACS410)	160315
22	Left side cover (access cover)	158-056686-000
23	Top cover	158-056685-000
23	Right side cover	158-056687-000
25	Front panel (need to order logo plate separately)	158-056679-000
26	Speaker	158-056684-000
27a	3.2-GB IDE hard disk, Quantum ST Ultra DMA	300668-01
27b	4.3-GB IDE hard disk, Quantum ST Ultra DMA	215-00125
27c	7-GB IDE hard disk, Maxtor	300800
27d	6.4-GB hard disk, IBM Ultra DMA	300815
27e	8.4-GB IDE hard disk, Maxtor 88400D8, UDMA	300819-01
27f	9.1-GB hard disk, UDMA	300833
27g	3.5"x1.6" 9.1-GB, Seagate Ultra wide SCSI, ST19171W	300689
27h	3.5"x1.6" 9.1-GB, Seagate Ultra wide SCSI, ST19101W	300690
27i	3.5"x1" 4.35-GB, Seagate Ultra wide SCSI, ST34371W	300652
27j	3.5"x1" 4.5-GB, Seagate Ultra wide SCSI, ST34501W	300691
28a	24x CD-ROM drive	730302-02
28b	32x CD-ROM drive (on certain models)	730330
29	Zip cartridge	142418
30	Iomega ATAPI Zip drive	320703
31	3.5-inch diskette drive	219-00012
32a	Ditto 3200 tape drive, backup	320547
32b	Seagate tape drive, CTT800I-S	320545
32c	SCSI tape backup unit, Seagate CTD8000R-S	320705

Table 5-5 Direction SPL and SP Series Minitower Field-Replaceable Parts List*

Item	Description	Part Number
	Cable, VMI — DVD PCI board to V330 video board (not shown in figure)	070805
	Cable, diskette drive, 655 mm, 3 connector (not shown in figure)	233-00013
	Power strip, surge protector (not shown in figure)	213-00009
	System power switch (not shown in figure)	130047
	Phone cable, modem (not shown in figure)	158-050519-001
	Card, sound wavetable OPL4 (not shown in figure)	030401
	SCSI cable, wide (not shown in figure)	233-00045
	CD, Restore Pkg., Windows 95 systems only (not shown in figure)	165326-08
	Battery (not shown in figure)	158-060367-000
	Monitor, NEC 15", C550 (not shown in figure)	011001
	Monitor, NEC 17", C700 (not shown in figure)	011002
	Cable, CD-ROM, audio (not shown in figure)	070112
	Microsoft SideWinder 3D joystick (not shown in figure)	160409
	DVD drive, Hitachi (not shown in figure)	730124
	DVD PCI board, Quadrant (not shown in figure)	060212
	DirecPC PCI board (not shown in figure)	149834
	Parallel printer cable (not shown in figure)	070829
	SPL233 logo plate (not shown in figure)	144724
	SPL266 logo plate (not shown in figure)	144722
	SPL300 logo plate (not shown in figure)	144725
	SPL333 logo plate (not shown in figure)	144758

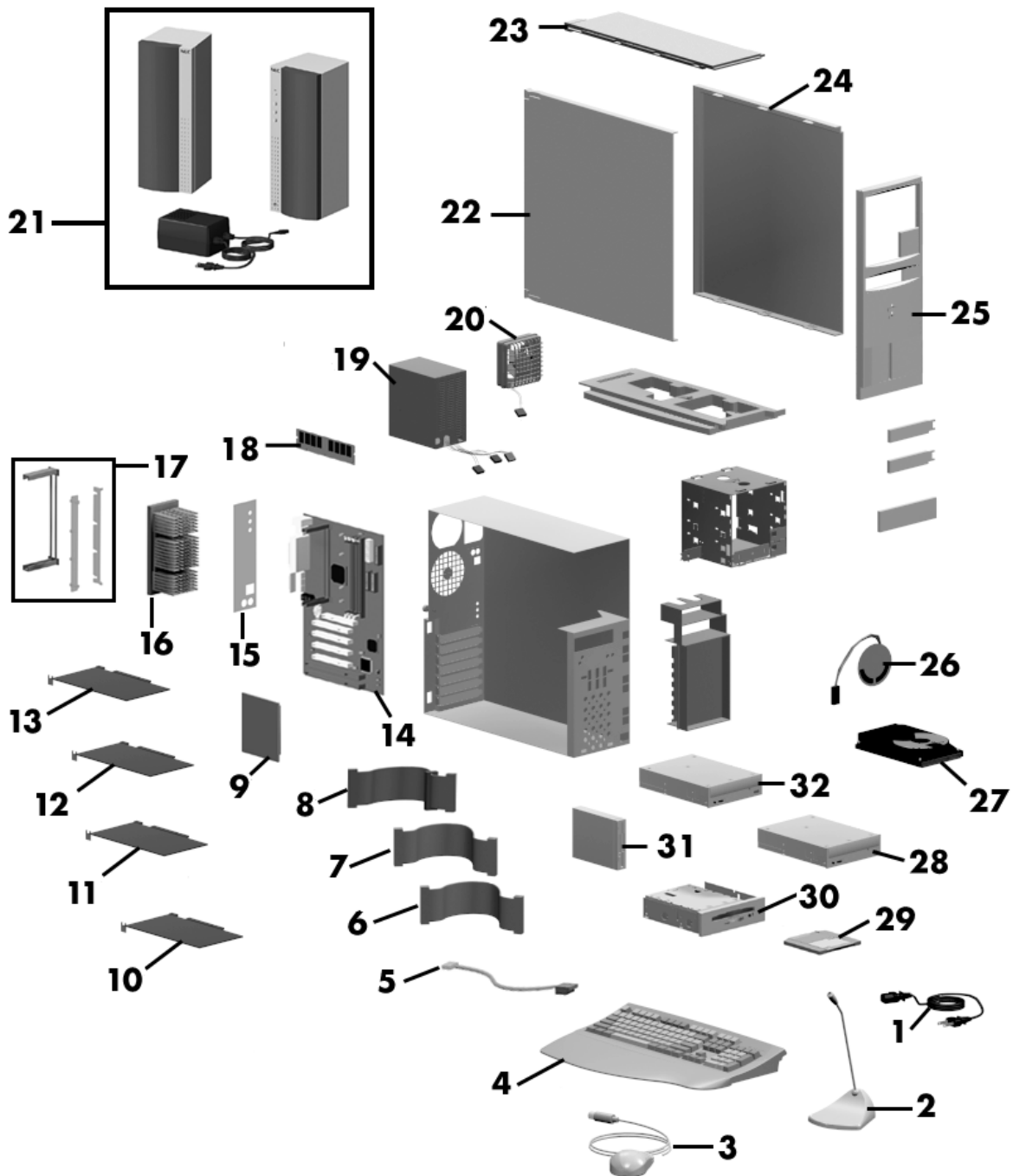

Figure 5-15 Direction SPL and SP Series Minitower Illustrated Parts Breakdown*

* This data was prepared June 1998. For an up-to-date listing of spare parts, please call FaxFlashSM at 1-888-329-0088 (or 1-978-635-6090 outside the U.S.) and order document 42102018.

Table 5-6 lists memory options.

Table 5-6 Memory Options

Description	Part Number
16-MB DIMM (non-parity)	81780
32-MB DIMM (non-parity)	81779
64-MB DIMM (non-parity)	81794

Table 5-7 lists the Direction Series documentation.

Table 5-7 Direction Series Documentation*

Description	Part Number
Direction Series User's Guide	102018-01
Direction Series Service and Reference Manual	102018-SRV

* This data was prepared June 1998. For an up-to-date listing of spare parts, please call FaxFlashSM at 1-888-329-0088 (or 1-978-635-6090 outside the U.S.) and order document 42102018.

Appendix A

System Specifications

This section describes the system specifications.

Processor

Microprocessor — 233-MHz, 266-MHz, 300-MHz, or 333-MHz Pentium II MMX

Clock Rate

- 200 MHz internally, 66 MHz externally
- 233 MHz internally, 66 MHz externally
- 300 MHz internally, 66 MHz externally
- 333 MHz internally, 66 MHz externally

Processor Support

- 32-bit addressing
- 64-bit data

Primary Cache — 32 KB of internal write-back cache on processor

Secondary Cache — 512 KB of pipeline burst cache

Processor Mounting

- Processor subsystem is inserted into slot 1 on the system board.
 - A 242-pin edge connector is implemented on the processor card for system board installation.
 - Each end of slot 1 has a Retention Mechanism Attach Mount (RMAM) inserted through the board. RMAM is made of two studs connected with a bridge.
 - Retention Mechanism (RM) is inserted over slot 1 to act as an insertion guide and prevent movement of processor after subsystem mounting.
 - RM is attached to RMAM by 4 captive nuts held to the guide with fasteners.
 - For thermal protection, a heatsink is supported by a Heat Sink Support (HSS), which is attached to the system board by two push pins.
 - The heatsink is secured in place to the HSS by an HSS top bar.
-

- The top bar is snapped into rigid pins after the processor subsystem (with heatsink) is inserted into the slot 1 connector and RM.

Random Access Memory (RAM)

Standard RAM — 32 MB to 192 MB of SDRAM installed in industry-standard DIMM sockets on system board

Total Memory — support for up to 384 MB of high-speed SDRAM

DIMM type — gold-plated, dual in-line modules (DIMMs)

Expansion — expandable using the following modules:

- 1-Mbit by 64 or 1-Mbit by 72 (8-MB DIMM)
- 2-Mbit by 64 or 2-Mbit by 72 (16-MB DIMM)
- 4-Mbit by 64 or 4-Mbit by 72 (32-MB DIMM)
- 8-Mbit by 64 or 8-Mbit by 72 (64-MB DIMM)
- 16-Mbit by 64 or 16-Mbit by 72 (128-MB DIMM).

Read-Only Memory (ROM)

Flash ROM — 2 Mbit

Window RAM (WRAM)

Standard video memory — 4 MB video memory on the video board

Calendar Clock

Year/Month/Day/Hour/Minute/Second/.01 Second; maintained by battery backup

Battery Type — Real Time Clock (RTC) battery

Input/Output (I/O) Facilities

Integrated Industry-Standard Interfaces

- Parallel — bidirectional, ECP/EPP support; one 25-pin connector
 - Serial — two high-speed RS-232C ports using 16550 UART, supports transfer rates up to 19.2 KB per second; 9-pin connectors
 - Universal Serial Bus (USB) — two USB ports, support two USB peripherals directly to the system; with appropriate connector, each port supports up to 127 daisy-chained devices; supports 12 megabits (Mbs) per second
-

- Keyboard — PS/2-compatible, 6-pin connector (mini DIN)
- Mouse — PS/2 compatible, 6-pin connector (mini DIN)
- IDE — dual IDE channels
 - one fast IDE and one standard IDE channel
 - CD-ROM drive and hard drive on separate channels
 - support for up to 10 MB/second 32-bit transfers on PCI bus
 - support for a total of four IDE devices; 40-pin connectors
 - support for mode 3 and mode 4

- Diskette Drive — supports two devices, 1.2-MB and 1.44-MB drives; 34-pin connector

Expansion Slots

I/O Bus — PCI/ISA

Six expansion slots

- One 8-/16-bit ISA slot
- Three 32-bit PCI slots
- One shared ISA/PCI slot
- One AGP slot

Keyboard and Mouse

Keyboard — Windows 95 enhanced, PS/2-compatible

- Function Keys — 12 keys, capable of up to 48 functions
- Status Lamps — numeric lock, capital lock, and scroll lock keys
- Numeric Keypad — standard
- Separate Cursor Control Keys — standard

Mouse — PS/2[®]-compatible; six-pin connector

Storage Devices

Accessible Devices

- 3 1/2-inch, 1.44-MB diskette drive
- CD-ROM/DVD drive
- Zip Drive — Iomega Zip 100 ATA drive on some systems; removable 100-MB data disks; data transfer rate up to 1.4 MB per second

Device Slots

Seven device slots:

- a 3.5-inch accessible device slot contains the standard 1.44-MB diskette drive
- one internal 3.5-inch hard drive slot for the hard drive, a second internal 3.5-inch hard drive slot is available
- four accessible device slots
 - One accessible 5.25-inch device slot contains the standard CD-ROM drive
 - One accessible 5.25-inch device slot
 - Two 3.5-inch device slots; the lower 3.5-inch slot is not accessible on the desktop model

Graphics

Video Memory — 4 MB

Support for High Color at 1024 by 768, 800 by 600, 640 by 480, and True Color at 800 by 600 and 640 by 480

- Graphics Support (with 4 MB video memory)
 - 1280 by 1024 pixels, 256 colors
 - 1024 by 768 pixels, 256/64,000 colors
 - 800 by 600 pixels, 256/64,000/16.8 million colors
 - 640 by 480 pixels, 16/256/64,000/16.8 million colors
 - Text
 - 80 columns by 25 lines
 - 132 columns by 25 lines
 - 132 columns by 43 lines
-

Sound System

Audio integrated on system board based on Yamaha OPL3-SA3 and OPL4-ML (in some systems)

- Compatible with Sound Blaster Pro™, Sound Blaster™ 2.0, Ad Lib™, MPU-401, and Microsoft® Windows Sound System™ for PC sound applications
- Stereo jacks — microphone in, line in, line out
- Built-in 16-bit sigma-delta stereo CODEC
- Dual DMA channel and built-in FIFOs for full duplex simultaneous playback and record in 16-bit stereo
- Programmable sample rate from 5.5 KHz to 48 KHz for recording and playback
- 6-bit (64 steps) master volume control
- IMA-compatible adaptive differential pulse code modulation (ADPCM), A-Law and u-Law compression/decompression
- DMA Demand mode, MPU-401 compatible MIDI interface
- Wave Blaster upgradeable for wavetable synthesis
- Built in 6-channel stereo mixer; supports 3 channel analog input
- Software programmable ISA bus interface (DMA, Interrupt, I/O address)
- Power down mode, dual master clock input
- Sound Retrieval System (SRS) for 3D sound effects
- Complies with General MIDI system level 1
- Wavetable synthesis to generate up to 24 voices simultaneously
- MIDI/Game connector — supports MIDI device or gaming device

Dimensions

System Unit

- Height — 17.1 in. (43.43 cm)
 - Desktop Width — 6.5 in. (16.51 cm)
 - Minitower Width — 7.8 in. (19.81)
 - Depth — 17.3 in. (43.94 cm)
-

Keyboard

- Height — 1.6 in. (4.1 cm)
- Width — 19.0 in. (48.3 cm)
- Depth — 8.4 in. (21.3 cm)

Weight

The following weights are averages. Weights depend upon the system configuration.

System Unit — 27.5 lb (12.46 kg)

Keyboard — 3.5 to 4 lb (1.6 to 1.8 kg)

Power

Universal Power Supply — 235 W

Power Management — Partial- and full-power reductions, Sleep button

Recommended Operating Environment

Temperature — 50°F to 95°F (10°C to 35°C)

Relative Humidity — 20% to 80%

Appendix B

Connector Pin Assignments

This appendix describes the system board connector pin assignments.

Table B-1 lists the connectors and sockets on the system board. The table also cross-references the page numbers where the connectors and their pinouts are described.

Table B-2 and Table B-3 list each connector by its function, number, and type.

Figure B-1 shows the locations of the connectors and slots on the system board. Figure B-2 shows the locations of the connectors on the back of the system unit.

Table B-1 System Board Connectors

Connector(s)	Page Number
Power supply	B-6
Diskette drive	B-8
IDE	B-9
DIMM Sockets	B-10
Front panel	B-7
ISA	B-11
PCI	B-13
AGP	B-
Parallel Interface	B-5
Serial Interface	B-4
Mouse/Keyboard	B-6
USB port	B-14

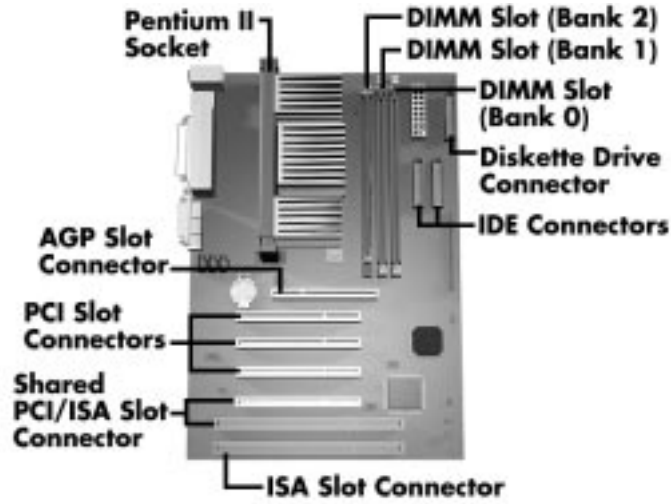

Figure B-1 System Board Connectors and Slots

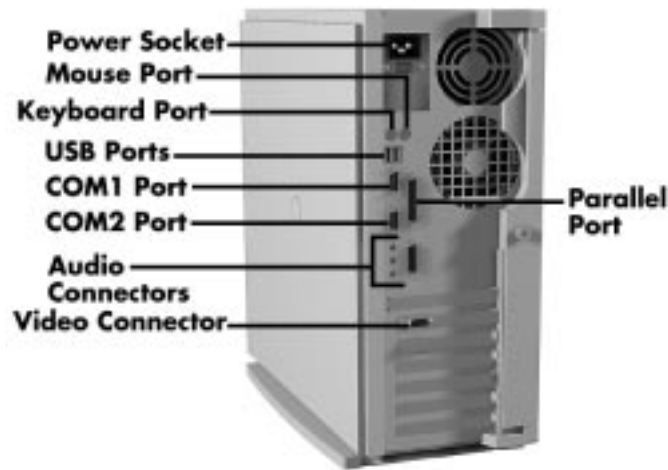

Figure B-2 System Board External Connectors

Table B-2 System Board Internal Connectors

Description	Connector Number
CD-ROM Audio	J1F1
Line-in Audio	J2F2
Telephony	J2F1
Fan 3	J5L1
Diskette Drive	J8K1
PCI IDE	J8H1, J7H1
Fan 1	J8M1
Fan 2	J3F1
Power Supply	J7L1

Table B-3 System Board Connector Numbers and Types

Function	Number	Type
Parallel Interface		25-pin female sub D-shell
Serial Interface (COM1 and COM2)		9-pin D-shell
Mouse		6-pin PS/2 style connector
Keyboard		6-pin PS/2 style connector
Diskette Drive	J8K1	2 x 17-pin male
Power Supply (Primary)	J7L1	2 x 10-pin locking header
DIMM Memory Sockets	J7J1 (Bank 0) J6J2 (Bank 1) J6J1 (Bank 2)	72 pin single inline connector
IDE Interface (primary)	J8H1	2 x 20-pin header
IDE Interface (secondary)	J7H1	2 x 20-pin header
Front Panel	J8H2	1 x 25-pin header
USB	J1L1	Female USB Stacked Connector

SERIAL INTERFACE CONNECTORS

Pin assignments for the serial interface port connector are listed in Table-B-4.

Table-B-4 RS-232C Serial Port Connector Pin Assignments

Pin	Signal	Description
1	DCD	Carrier detect
2	Serial In#	Receive data
3	Serial Out#	Transmit data
4	DTR#	Data terminal ready
5	Ground	Signal ground
6	DSR	Data set ready
7	RTS	Request to send
8	CTS	Clear to send
9	RI	Ring indicator

PARALLEL INTERFACE CONNECTOR

Parallel interface specifications for this port conform to the IBM-PC interface. Pin assignments for the parallel interface connector are listed in Table B-5.

Table B-5 Parallel Port Connector Pin Assignments

Pin	Signal	Pin	Signal
1	Strobe#	14	Auto feed#
2	Data bit 0	15	Fault#
3	Data bit 1	16	INIT# (Initialize)
4	Data bit 2	17	SLCT IN# (Select in)
5	Data bit 3	18	Ground
6	Data bit 4	19	Ground
7	Data bit 5	20	Ground
8	Data bit 6	21	Ground
9	Data bit 7	22	Ground
10	ACK# (Acknowledge)	23	Ground
11	Busy	24	Ground
12	Error	25	Ground
13	Select		

POWER SUPPLY (PRIMARY)

Voltages from the power supply are input to the system board through the primary power supply connector. Table B-6 shows the connector pin locations and pin assignments.

Table B-6 Primary Power Supply Connector Pin Assignments

Pin	Signal	Pin	Signal
1	+3.3 V	11	+3.3 V
2	+3.3 V	12	-12 V
3	Ground	13	Ground
4	+5 V	14	PS-ON# (Power supply remote on/off control)
5	Ground	15	Ground
6	+5 V	16	Ground
7	Ground	17	Ground
8	PWRGD (Power Good)	18	-5 V
9	+5 VSB (Standby for real-time clock)	19	+5 V
10	+12 V	20	+5 V

KEYBOARD AND MOUSE CONNECTORS

The keyboard and mouse use standard PS/2 connectors. Pin assignments are given in Table B-7.

Table B-7 Keyboard and Mouse Connector Pin Assignments

Pin	Keyboard Connector	Mouse Connector
1	Keyboard Data	Mouse Data
2	No connect	No connect
3	Ground	Ground
4	+5V (fused)	+5V (fused)
5	Keyboard Clock	Mouse Clock
6	No connect	No connect

FRONT PANEL

The front panel connector provides cabling for the buttons and panel LEDs (power and hard disk). The connector pin assignments are given in Table B-8.

Table B-8 Front Panel Connector Pin Assignments

Pin	Signal	Description
1	SW_ON#	Power On
2	Ground	
3	SLEEP	Sleep/Resume
4	SLEEP_PU (pull up)	
5	No connect	none
6	+5V	IrDA
7	Key	
8	IrRX	
9	Ground	
10	IrTX	
11	CONIR (Consumer IR)	
12	No connect	none
13	HD_PWR +5V	HD LED
14	Key	
15	HD Active#	
16	HD_PWR	
17	No connect/Key	none
18	Ground	Sleep/Power LED
19	Key	
20	PWR_LED	
21	No connect/Key	none
22	Ground	Reset
23	SW_RST	
24	Ground	Speaker
25	Key	
26	PIEZO_IN	
27	SPKR_HDR	

DISKETTE DRIVE INTERFACE PIN ASSIGNMENTS

Table B-9 provides the pin assignments for the diskette drive interface connector.

Table B-9 Diskette Drive Connector Pin Assignments

Pin	Description	Pin	Description
1	Ground	2	DENSEL
3	Ground	4	Reserved
5	Key	6	FDEDIN
7	Ground	8	FDINDX# (Index)
9	Ground	10	FDM00# (Motor enable A)
11	Ground	12	FDDS1# (Drive select B)
13	Ground	14	FDDS0# (Drive select A)
15	Ground	16	FDM01# (Motor enable B)
17	MSEN1	18	FDDIR# (Stepper motor direction)
19	Ground	20	FDSTEP# (Step pulse)
21	Ground	22	FDWD# (Write data)
23	Ground	24	FDWE# (Write gate)
25	Ground	26	FDTRK0# (Track 0)
27	MSEN0	28	FDWPD# (Write protect)
29	Ground	30	FDRDATA (Read data)
31	Ground	32	FDHEAD# (Side 1 select)
33	Ground	34	DSKCHG# (Diskette change)

IDE INTERFACE CONNECTORS

All signal levels in the IDE interface are TTL compatible. A logic 1 is a signal whose voltage level is between 2.0 and 5.0 V. A logic 0 is a signal measuring between 0.00 V and 0.70 V.

The two system board IDE connectors are physically identical. Electrically, the primary IDE/PCI bus IDE connector is faster and the secondary IDE/PCI connector is slower. Table B-10 provides the IDE pin assignments. All signals on the Host interface have the prefix HOST. All negatively active signals are further prefixed with a “-” designation. All positively active signals are prefixed with a “+” designation.

Table B-10 IDE/PCI Connector Pin Assignments

Pin	Description	Pin	Description
1	Reset IDE	2	Ground
3	Host data 7	4	Host data 8
5	Host data 6	6	Host data 9
7	Host data 5	8	Host data 10
9	Host data 4	10	Host data 11
11	Host data 3	12	Host data 12
13	Host data 2	14	Host data 13
15	Host data 1	16	Host data 14
17	Host data 0	18	Host data 15
19	Ground	20	Key
21	DDRQ0 (DDRQ1)	22	Ground
23	I/O write#	24	Ground
25	I/O read#	26	Ground
27	IOCHRDY	28	P_ALE (Cable select pullup)
29	DDACK# (DDACK1#)	30	Ground
31	IRQ 14 (IRQ 15)	32	Reserved
33	Address 1	34	Reserved
35	Address 0	36	Address 2
37	Chip select 1P# (Chip select 1S#)	38	Chip select 3P# (Chipselect 3S#)
39	Activity#	40	Ground

Note: Signal names in parentheses () are for the secondary IDE connector.

DIMM SOCKETS

Table B-11 provides the DIMM type, configuration, and technology by DIMM size.

Table B-11 DIMM Socket Pin Assignments

Pin	Description	Pin	Description	Pin	Description	Pin	Description
1	V _{SS}	43	V _{SS}	85	V _{SS}	127	V _{SS}
2	DQ0	44	NC	86	DQ32	128	CKE0
3	DQ1	45	$\overline{S2}$	87	DQ33	129	NC
4	DQ2	46	DQM2	88	DQ34	130	DQM6
5	DQ3	47	DQM3	89	DQ35	131	DQM7
6	V _{DD}	48	NC	90	V _{DD}	132	NC (A13)
7	DQ4	49	V _{DD}	91	DQ36	133	V _{DD}
8	DQ5	50	NC	92	DQ37	134	NC
9	DQ6	51	NC	93	DQ38	135	NC
10	DQ7	52	CB2	94	DQ39	136	CB6
11	DQ8	53	CB3	95	DQ40	137	CB7
12	V _{SS}	54	V _{SS}	96	V _{SS}	138	V _{SS}
13	DQ9	55	V _{SS}	97	DQ41	139	DQ48
14	DQ10	56	DQ17	98	DQ43	140	DQ49
15	DQ11	57	DQ18	99	DQ43	141	DQ50
16	DQ12	58	DQ19	100	DQ44	142	DQ51
17	V _{DD}	59	V _{DD}	101	DQ45	143	V _{DD}
18	V _{DD}	60	DQ20	102	V _{DD}	144	DQ52
19	DQ14	61	NC	103	DQ46	145	NC
20	DQ15	62	NC (V _{REF})	104	DQ47	146	NC (V _{REF})
21	CB0	63	CKE1	105	CB4	147	NC
22	CB1	64	V _{SS}	106	CB5	148	V _{SS}
23	V _{SS}	65	DQ21	107	V _{SS}	149	DQ53
24	NC	66	DQ22	108	NC	150	DQ54
25	NC	67	DQ23	109	NC	151	DQ55
26	V _{DD}	68	V _{SS}	110	V _{DD}	152	V _{SS}
27	\overline{WE}	69	DQ24	111	\overline{CAS}	153	DQ56
28	DQM0	70	DQ25	112	DQM4	154	DQ57
29	DQM1	71	DQ26	113	DQM5	155	DQ58
30	$\overline{S0}$	72	DQ27	114	NC	156	DQ59
31	NC	73	V _{DD}	115	\overline{RAS}	157	V _{DD}
32	V _{SS}	74	DQ28	116	V _{SS}	158	DQ60
33	A0	75	DQ29	117	A1	159	DQ61
34	A2	76	DQ30	118	A3	160	DQ62
35	A4	77	DQ31	119	A5	161	DQ63
36	A6	78	V _{SS}	120	A7	162	V _{SS}
37	A8	79	CK2	121	A9	163	CK3
38	A10	80	NC	122	BA0	164	NC
39	NC (BA1)	81	NC	123	NC (A11)	165	SA0
40	V _{DD}	82	SDA	124	V _{DD}	166	SA1
41	V _{DD}	83	SCL	125	CK1	167	SA2
42	CK0	84	V _{DD}	126	NC (A12)	168	V _{DD}

AGP CONNECTOR

Table B-12 provides the pin assignments for the AGP slot.

Table B-12 AGP Connector Pin Assignments

Pin	Description	Pin	Description	Pin	Description	Pin	Description
A1	+12V	B1	No connect	A34	Vcc3.3	B34	Vcc3.3
A2	No connect	B2	Vcc	A35	AGP_AD22	B35	AGP_AD21
A3	Reserved	B3	Vcc	A36	AGP_AD20	B36	AGP_AD19
A4	No connect	B4	No connect	A37	Ground	B37	Ground
A5	Ground	B5	Ground	A38	AGP_AD18	B38	AGP_AD17
A6	PIRQ0#	B6	PIRQ1#	A39	AGP_AD16	B39	AGP_CBE2
A7	RST#	B7	HCLK_AGP	A40	Vcc3.3	B40	Vcc3.3
A8	AGP_GNT1#	B8	AGP_REQ1	A41	AGP_FRAME#	B41	AGP_IRDY#
A9	Vcc3.3	B9	Vcc3.3	A42	Reserved	B42	Reserved
A10	AGP_ST1	B10	AGP_ST0	A43	Ground	B43	Ground
A11	Reserved	B11	AGP_ST2	A44	Reserved	B44	Reserved
A12	AGP_PIPE#	B12	AGP_DBF#	A45	Vcc3.3	B45	Vcc3.3
A13	Ground	B13	Ground	A46	AGP_TRDY#	B46	AGP_DEVSEL#
A14	No connect	B14	No connect	A47	AGP_STOP#	B47	Vcc3.3
A15	SBA1	B15	SBA0	A48	No connect	B48	AGP_PERR#
A16	Vcc3.3	B16	Vcc3.3	A49	Ground	B49	Ground
A17	SBA3	B17	SBA2	A50	AGP_PAR	B50	AGP_SERR#
A18	Reserved	B18	SB_STB	A51	AGP_AD15	B51	AGP_CBE1
A19	Ground	B19	Ground	A52	Vcc3.3	B52	Vcc3.3
A20	SBA5	B20	SBA4	A53	AGP_AD13	B53	AGP_AD14
A21	SBA7	B21	SBA6	A54	AGP_AD11	B54	AGP_AD12
A22	Key	B22	Key	A55	Ground	B55	Ground
A23	Key	B23	Key	A56	AGP_AD9	B56	AGP_AD10
A24	Key	B24	Key	A57	AGP_CBE0	B57	AGP_AD8
A25	Key	B25	Key	A58	Vcc3.3	B58	Vcc3.3
A26	AGP_AD30	B26	AGP_AD31	A59	Reserved	B59	AD_STBA
A27	AGP_AD28	B27	AGP_AD29	A60	AGP_AD6	B60	AGP_AD7
A28	Vcc3.3	B28	Vcc3.3	A61	Ground	B61	Ground
A29	AGP_AD26	B29	AGP_AD27	A62	AGP_AD4	B62	AGP_AD5
A30	AGP_AD24	B30	AGP_AD25	A63	AGP_AD2	B63	AGP_AD3
A31	Ground	B31	Ground	A64	Vcc3.3	B64	Vcc3.3
A32	Reserved	B32	AD_STBB	A65	AGP_AD0	B65	AGP_AD1
A33	AGP_CBE3	B33	AGP_AD23	A66	No connect	B66	No connect

ISA EXPANSION BUS CONNECTOR PIN ASSIGNMENTS

The expansion slots signals, voltages, and grounds are supplied through the bus connectors. Table B-13 provides the pin assignments for the ISA expansion slots.

Table B-13 ISA Expansion Slot Pin Assignments

Pin	Direction	Signal	Pin	Direction	Signal
A1	Input	IOCHCK#	B1	Ground	GND
A2	Input/Output	SD7	B2	Reset	RESDRV
A3	Input/Output	SD6	B3	Power	+5V
A4	Input/Output	SD5	B4	Input	IRQ09
A5	Input/Output	SD4	B5	Power	-5V
A6	Input/Output	SD3	B6	Input	DRQ2
A7	Input/Output	SD2	B7	Power	-12V
A8	Input/Output	SD1	B8	Input	SRDY#(N0WS#)
A9	Input/Output	SD0	B9	Power	+12V
A10	Input	IOCHRDY	B10	Ground	GND
A11	Output	AEN	B11	Output	SMEMW# (SMWTC#)
A12	Input/Output	SA19	B12	Output	SMEMR# (SMRDC#)
A13	Input/Output	SA18	B13	Input/Output	IOW# (IOWC#)
A14	Input/Output	SA17	B14	Input/Output	IOR# (IOWC#)
A15	Input/Output	SA16	B15	Output	DACK3#
A16	Input/Output	SA15	B16	Input	DRQ3
A17	Input/Output	SA14	B17	Output	DACK1
A18	Input/Output	SA13	B18	Input	DRQ1
A19	Input/Output	SA12	B19	Input/Output	REFRESH#
A20	Input/Output	SA11	B20	Output	BCLK
A21	Input/Output	SA10	B21	Input	IRQ7
A22	Input/Output	SA9	B22	Input	IRQ6
A23	Input/Output	SA8	B23	Input	IRQ5
A24	Input/Output	SA7	B24	Input	IRQ4
A25	Input/Output	SA6	B25	Input	IRQ3
A26	Input/Output	SA5	B26	Output	DACK2#
A27	Input/Output	SA4	B27	Output	TC
A28	Input/Output	SA3	B28	Output	BALE
A29	Input/Output	SA2	B29	Power	+5V

Table B-13 ISA Expansion Slot Pin Assignments

Pin	Direction	Signal	Pin	Direction	Signal
A30	Input/Output	SA1	B30	Output	OSC
A31	Input/Output	SA0	B31	Ground	GND
C1	Input/Output	SBHE#	D1	Input	MEMCS16# (M16#)
C2	Input/Output	LA23	D2	Input	IOCS16# (IO16#)
C3	Input/Output	LA22	D3	Input	IRQ10
C4	Input/Output	LA21	D4	Input	IRQ11
C5	Input/Output	LA20	D5	Input	IRQ12
C6	Input/Output	LA19	D6	Input	IRQ15
C7	Input/Output	LA18	D7	Input	IRQ14
C8	Input/Output	LA17	D8	Output	DACK0#
C9	Input/Output	MEMR# (MRDC#)	D9	Input	DRQ0
C10	Input/Output	MEMW# (MWTC#)	D10	Output	DACK5#
C11	Input/Output	SD8	D11	Input	DRQ5
C12	Input/Output	SD9	D12	Output	DACK6#
C13	Input/Output	SD10	D13	Input	DRQ6
C14	Input/Output	SD11	D14	Output	DACK7#
C15	Input/Output	SD12	D15	Input	DRQ7
C16	Input/Output	SD13	D16	Power	+5V
C17	Input/Output	SD14	D17	Input	Master16# (MASTER#)
C18	Input/Output	SD15	D18	Ground	GND

PCI EXPANSION BUS CONNECTOR PIN ASSIGNMENTS

The expansion slots signals, voltages, and grounds are supplied through the bus connectors. Table B-14 provides the pin assignments for the PCI expansion slots.

Table B-14 PCI Expansion Pin Assignments

Pin	Signal	Pin	Signal	Pin	Signal	Pin	Signal
A1	+5V (TRST#)	B1	-12V	A32	AD16	B32	AD17
A2	+12V	B2	Ground (TCK)	A33	+3.3V	B33	C/BE2#
A3	+5V (TMS)*	B3	Ground	A34	FRAME#	B34	Ground
A4	+5V (TDI)	B4	no con (TDO)	A35	Ground	B35	IRDY#
A5	+5V	B5	+5V	A36	TRDY#	B36	+3.3V
A6	INTA#	B6	+5V	A37	Ground	B37	DEVSEL#
A7	INTC#	B7	INTB#	A38	STOP#	B38	Ground
A8	+5V	B8	INTD#	A39	+3.3V	B39	LOCK#
A9	Reserved	B9	PRSNT#	A40	SDONE	B40	PERR#
A10	+5V (I/O)	B10	Reserved	A41	SBO#	B41	+3.3V
A11	Reserved	B11	PRSNT2#	A42	Ground	B42	SERR#
A12	Ground	B12	Ground	A43	PAR	B43	+3.3v
A13	Ground	B13	Ground	A44	AD15	B44	C/BE1#
A14	Reserved	B14	Reserved	A45	+3.3V	B45	AD14
A15	RST#	B15	Ground	A46	AD13	B46	Ground
A16	+5V (I/O)	B16	CLK	A47	AD11	B47	AD12
A17	GNT#	B17	Ground	A48	Ground	B48	AD10
A18	Ground	B18	REQ#	A49	AD09	B49	Ground
A19	Reserved	B19	+5V (I/O)	A50	Key	B50	Key
A20	AD30	B20	AD31	A51	Key	B51	Key
A21	+3.3V	B21	AD29	A52	C/BE0#	B52	AD08
A22	AD28	B22	Ground	A53	+3.3V	B53	AD07
A23	AD26	B23	AD27	A54	+AD06	B54	+3.3V
A24	Ground	B24	AD25	A55	AD04	B55	AD05
A25	AD24	B25	+3.3V	A56	Ground	B56	AD03
A26	IDSEL	B26	C/BE3#	A57	AD02	B57	Ground
A27	+3.3V	B27	AD23	A58	AD00	B58	AD01
A28	AD22	B28	Ground	A59	+5V (I/O)	B59	+5V (I/O)
A29	AD20	B29	AD21	A60	REQ64C3	B60	+5v
A30	Ground	B30	AD19	A61	+5V	B61	+5V
A31	AD18	B31	+3.3V	A62	+5V	B62	+5V

UNIVERSAL SERIAL BUS (USB) CONNECTORS

Table B-15 lists the pin assignments and signal names for the USB connectors.

Table B-15 USB Connectors

Pin	Signal Name
1	Power
2	USBP0# (USBP1#)
3	USBP0 (USBP1)
4	Ground

Appendix C

System Resources

The following sections include information about:

- default system settings
- viewing system resources
- jumper settings on the system board.

IRQ SETTINGS

The following settings are the default IRQ settings:

- IRQ0 (timer)
 - IRQ1 (keyboard)
 - IRQ2 (cascade interrupt)
 - IRQ3 (COM2)
 - IRQ4 (COM1)
 - IRQ5 (LPT2)
 - IRQ6 (diskette drive)
 - IRQ7 (LPT1)
 - IRQ8 (real time clock)
 - IRQ9 (reserved)
 - IRQ10 (user available)
 - IRQ11 (Windows Sound System/user available)
 - IRQ12 (mouse)
 - IRQ13 (coprocessor)
 - IRQ14 (primary IDE)
 - IRQ15 (secondary IDE).
-

VIEWING SYSTEM RESOURCES

Some hardware option installations might require system resources such as interrupt request (IRQ) lines, direct memory access (DMA) channels, and input/output (I/O) addresses. See the following procedures to view system resources.

Follow these steps to view system resources:

1. From the Windows 95 desktop, click the “My Computer” icon with the **right** mouse button.
2. Click “Properties.” The System Properties box appears.
3. Click the Device Manager tab.
4. Double click “Computer.” The Computer Properties box appears and displays the View Resources folder.

The View Resources folder shows the system resources used by your computer. For example, it shows a list of interrupts and how they are allocated. If an interrupt is not in the list, it is available.

SETTING THE JUMPER

The following figure shows the jumper location on the system board.

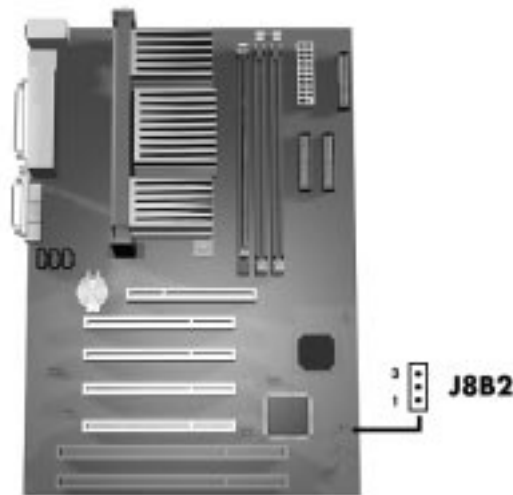

Figure C-1 Locating the Jumper

The following table summarizes the system board jumper settings.

Table C-1 System Board Jumper Settings

Function	Jumper J8B2	Configuration
Normal	1-2	The BIOS uses current configuration information and passwords for booting.
Configure	2-3	After POST, Setup runs automatically. The Maintenance Menu appears.
Recovery	None	BIOS attempts to recover the BIOS configuration. A BIOS recovery diskette is required.

Clearing Your Password

The following sections describe how to clear your password.

1. Turn off the power and unplug the system and any peripherals.

WARNING: Turn off the system before you change any jumper settings.

2. Remove the access cover (see Section 3, “Removing the Access Cover”).
3. Locate the Configuration jumper (J8B2) on the system board (see “Locating the Jumper” in the previous subsection).
4. You may have to remove any installed expansion boards to access the jumper (see Section 3, “Expansion Board Removal”).
5. Remove the jumper block from pins 1-2 and set it on pins 2-3. We recommend that you use needle nose pliers to move a jumper.
6. Replace the access cover (see Section 3, “Replacing the Access Cover”).
7. Connect system power cables and monitor.
8. Power on the system.

The system enters Setup and the Maintenance menu appears. You can disable the user and supervisor passwords.

WARNING: If you removed the jumper, the system attempts to recover the BIOS. A recovery diskette is needed.

9. Power off, unplug the system and monitor, and remove the access cover.
10. Remove the jumper block from pins 2-3 and replace it on pins 1-2.
11. If you removed any expansion boards, replace them (see Section 3, “Expansion Board Installation”).
12. Replace the access cover. Reconnect the system power cables and peripheral devices.
13. Power on the system.
14. Run Setup (see Section 2).

Recovering the BIOS

The following sections describe how to recover the system BIOS.

1. Turn off the power and unplug the system and any peripherals.

WARNING: Turn off the system before you change any jumper settings.

2. Remove the access cover (see Section 3, “Removing the Access Cover”).
3. Locate the Configuration jumper (J8B2) on the system board (see “Locating the Jumper” in the previous subsection).
4. You may have to remove any installed expansion boards to access the jumper (see Section 3, “Expansion Board Removal”).
5. Remove the jumper block from pins 1-2. We recommend that you use needle nose pliers to move a jumper.
6. Replace the access cover (see Section 3, “Replacing the Access Cover”).
7. Connect system power cables and monitor.
8. Power on the system.

The system attempts to recover the BIOS. A recovery diskette is needed.

9. Power off, unplug the system and monitor, and remove the access cover.
 10. Replace it on pins 1-2.
-

- 11.** If you removed any expansion boards, replace them (see Section 3, “Expansion Board Installation”).
- 12.** Replace the access cover. Reconnect the system power cables and peripheral devices.
- 13.** Power on the system.
- 14.** Run Setup (see Section 2).

Index

B

BIOS recovery, C-4

C

CD-ROM/DVD drive, 1-11

Checking hard disk drive parameters, 2-7

CMOS battery, 4-11

 replacement, 4-11

Configurations, 1-1

 setup, 2-1

Connectors, B-1

 AGP, B-11

 DIMM sockets, B-10

 diskette drive, B-8

 IDE interface, B-9

 ISA expansion bus, B-12

 keyboard, B-6

 mouse, B-6

 PCI expansion bus, B-14

 power supply, B-6

 serial interface, B-4

Cover removal, 3-3, 3-4

D

Device installation

 3 1/2-inch, 3-19

 5 1/4-inch, 3-23

DIMM installation, 3-10

DIMM module

 removal, 5-9

DIMMs

 upgrade, 3-7

Disassembly, 5-1

 3 1/2-inch hard disk drive, 5-6

 5 1/4-inch device, 5-5

 device cage, 5-4

 DIMM module, 5-9

 diskette drive, 5-4

 expansion boards, 5-2

 fan assembly, 5-8

 front panel, 5-3

 power supply, 5-10

 side panel, 5-4

 standard 3 1/2-inch hard drive, 5-8

 system board, 5-11

 system unit, 5-2

E

Expansion board

 removal, 3-7

Expansion board installation, 3-5

External options, 3-25

 parallel printer, 3-25

 serial devices, 3-27

F

Front panel removal, 3-18

Front panel replacement, 3-24

H

Hard disk drive, 1-11

 optional 3/1-2 inch hard drive

 removal, 5-6

 standard 3 1/2-inch hard drive

 removal, 5-8

Hard disk drive parameters, 2-7

I

Installing options

 interrupts, C-2

 system resources, C-2

Interrupts, C-2

IRQs, C-2

J

Jumper location, C-2

Jumper settings, C-2

K

Keyboard

 cleaning, 4-3

M

Maintenance, 4-2

- keyboard cleaning, 4-3
- mouse cleaning, 4-3
- system cleaning, 4-2

Mouse

- cleaning, 4-3

Multimedia components

- CD-ROM /DVD drive, 1-11

N

NEC CSD telephone numbers, 4-1

O

Operation, 2-1

Option installation, 3-1

- cover removal, 3-3
- expansion board removal, 3-7
- external options, 3-25
- precautions, 3-2

P

Password

- clearing, C-3

Power management, 1-11

Power supply, 1-11

- removal, 5-10

R

Reassembly, 5-1

Removing expansion board, 3-7

Repair, 5-1

- disassembly, 5-1
- reassembly, 5-1

S

Setup, 2-1

Setup and Operation, 2-1

Setup utility

- legend bar, 2-4

storage device installation, 3-11, 3-18

- device cables, 3-13
- device preparation, 3-12
- device slots, 3-11, A-4

System board, 1-4

connectors, B-1

removal, 5-11

System cleaning, 4-2

System configurations, 1-1

System resources, C-2

System specifications, A-1

System unit

disassembly, 5-2

System unit disassembly, 5-2

5 1/4-inch device, 5-5

DIMM module, 5-9

expansion board, 5-2

front panel, 5-3

optional 3 1/2-inch hard disk drive,
5-6

power supply, 5-10

standard 3 1/2-inch hard disk, 5-8

system board, 5-11

T

Troubleshooting, 4-5

problems and solutions, 4-5

(For United States Use Only)

FEDERAL COMMUNICATIONS COMMISSION RADIO FREQUENCY INTERFERENCE STATEMENT

WARNING: Changes or modifications to this unit not expressly approved by the party responsible for compliance could void the user's authority to operate the equipment.

NOTE: This equipment has been tested and found to comply with the limits for a Class B digital device, pursuant to Part 15 of the FCC Rules. These limits are designed to provide reasonable protection against harmful interference in a residential installation. This equipment generates, uses and can radiate radio frequency energy and, if not installed and used in accordance with the instructions, may cause harmful interference to radio communications.

However, there is no guarantee that interference will not occur in a particular installation. If this equipment does cause harmful interference to radio or television reception, which can be determined by turning the equipment off and on, the user is encouraged to try to correct the interference by one or more of the following measures.

- Reorient or relocate the receiving antenna.
- Increase the separation between the equipment and receiver.
- Connect the equipment to an outlet on a circuit different from the one to which the receiver is connected.

Use a shielded and properly grounded I/O cable to ensure compliance of this unit to the specified limits of the rules.

FCC Modem Connection Requirements

The Federal Communications Commission (FCC) has established Rules that permit this device to be directly connected to the telephone network. Standardized jacks are used for these connections. This equipment should not be used on party lines or coin lines.

If the modem is malfunctioning, it may also be harming the telephone network. Disconnect the modem until the source of the problem is determined and repairs are made. If this is not done, the telephone company may temporarily disconnect service.

The telephone company may make changes in its technical operations and procedures. If such changes affect the compatibility or use of the modem, the telephone company is required to give adequate notice of the changes. You will be advised of your right to file a complaint with the FCC.

If the telephone company requires information on what equipment is connected to their lines, inform them of:

- The telephone number to which this unit is connected
- The ringer equivalence number (see the modem label)
- The USOC jack required.
- The FCC Registration number (see the modem label).

The ringer equivalence (REN) is used to determine how many devices can be connected to your telephone line. In most areas, the sum of the RENs of all devices on any one line should not exceed five (5). If too many devices are attached, they may not ring properly.

Modem Service Requirements

If the modem malfunctions, all repairs should be performed by NEC Computer Systems Division or an NEC CSD Authorized Service Center. It is the responsibility of users requiring service to report the need for service to NEC Computer Systems Division or to an NEC CSD Authorized Service Center. Service can be obtained at:

Phone: 1-888-632-2678

(For Canadian Use Only)

This equipment is a Class B digital apparatus which complies with the Radio Interference Regulations, C.R.C., c.1374.

Cet appareil numérique de la classe B est conforme au Règlement sur le brouillage radioélectrique, C.R.C., ch.1374.

Canadian Department of Communications Modem Connection Requirements

NOTE: The Canadian Department of Communications label identifies certified equipment. This certification means that the equipment meets certain telecommunications network protective, operational and safety requirements. The Department does not guarantee the equipment will operate to the user's satisfaction.

Before installing this equipment, users should ensure that it is permissible to be connected to the facilities of the local telecommunications company. The equipment must also be installed using an acceptable method of connection. In some cases, the company's inside wiring associated with a single line individual service may be extended by means of a certified connector assembly (telephone extension cord). The customer should be aware that compliance with the above conditions may not prevent degradation of service in some situations.

Repairs to certified equipment should be made by an authorized Canadian maintenance facility designated by the supplier. Any repairs or alterations made by the user to this equipment, or equipment malfunctions, may give the telecommunications company cause to request the user to disconnect the equipment.

Users should ensure for their own protection that the electrical ground connections of the power utility, telephone lines and internal metallic water pipe system, if present, are connected together. This precaution may be particularly important in rural areas.

WARNING: Users should not attempt to make such connections themselves, but should contact the appropriate inspection authority or electrician.

The Load Number (LN) assigned to each terminal device denotes the percentage of the total load to be connected to a telephone loop which is used by the device, to prevent overloading. The termination on a loop may consist of any combination of devices subject only to the requirement that the total of the Load Numbers of all the devices does not exceed 100.

BATTERY REPLACEMENT

A lithium battery in your computer maintains system configuration information. In the event that the battery fails to maintain system configuration information, NEC CSD recommends that you replace the battery (see Section 4, "Maintenance and Troubleshooting," for battery removal procedures).

WARNING: There is a danger of explosion if the battery is incorrectly replaced. Replace only with the same or equivalent type recommended by the manufacturer. Discard used batteries according to the manufacturer's instructions.

ATTENTION: Il y a danger d'explosion s'il y a remplacement incorrect de la batterie. Remplacer uniquement avec une batterie du même type ou d'un type recommandé par le constructeur. Mettre au rebut les batteries usagées conformément aux instructions du fabricant.

BATTERY DISPOSAL

Do not place used batteries in your regular trash.

The nickel-cadmium or nickel metal-hydrate batteries must be collected, recycled, or disposed of in an environmentally-approved manner.

The incineration, landfilling, or mixing of batteries with the municipal solid waste stream is **prohibited by law** in most areas.

Return batteries to a federal or state approved battery recycler. This may be where you purchased the battery or a local seller of automotive batteries.

Contact your local waste management officials for other information regarding the environmentally sound collection, recycling, and disposal of the batteries.